



KW-M150BT

MONITOR WITH RECEIVER

INSTRUCTION MANUAL

JVC KENWOOD Corporation

- Updated information (the latest Instruction Manual, etc.) is available from <http://www.jvc.net/cs/car/>.

Model name indication position

See "Removing the trim plate" (P.23)

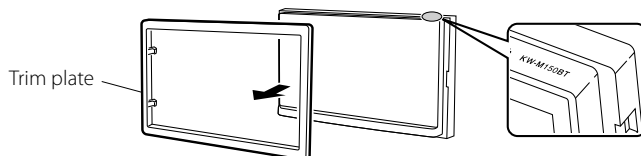

Contents

Before use	2
How to read this manual	2
Precautions	2
Getting Started	3
Clock settings	3
Basics	4
Functions of the Buttons on the Front Panel	4
Common operations	4
HOME screen descriptions	5
List screen	5
Tuner	6
Tuner Basic Operation	6
Presetting stations	6
Tuner Setup	7
USB	8
Preparation	8
Playback operations	8
iPod/iPhone	10
Preparation	10
Playback operations	10
Mirroring	12
Preparation	12
Mirroring operations	12
External Components	13
Using external audio/video players	13
Rear view camera	13
Learning function of steering remote	14
Bluetooth	15
Register your smartphone to the unit	15
Bluetooth Setup	15
Receive a phone call	16
Make a phone call	16
Playing Bluetooth Audio Device	17
Controlling Audio	18
Controlling General Audio	18
Equalizer Control	18
Speaker / X'Over setup	19
Listening Position / DTA	19
Sound Effect	19
Remote control	20
Functions of the Remote control Buttons	20
Installation	21
Before Installation	21
Installing the unit	22
About this Unit	26
More information	26
Troubleshooting	26
Copyrights	27
Specifications	28

How to read this manual

- The panels shown in this guide are examples used to provide clear explanations of the operations. For this reason, they may be different from the actual panels.
- In operation procedures, bracket shape indicates the key or button you should control.
 - < >: indicates the name of panel buttons.
 - []: indicates the name of touch keys

Before use

Precautions

▲WARNING

■ To prevent injury or fire, take the following precautions:

- To prevent a short circuit, never put or leave any metallic objects (such as coins or metal tools) inside the unit.
- Do not watch or fix your eyes on the unit's display when you are driving for any extended period.
- If you experience problems during installation, consult your JVC dealer.

■ Precautions on using this unit

- When you purchase optional accessories, check with your JVC dealer to make sure that they work with your model and in your area.
- The Radio Data System or Radio Broadcast Data System feature won't work where the service is not supported by any broadcasting station.

■ Protecting the monitor

- To protect the monitor from damage, do not operate the monitor using a ballpoint pen or similar tool with the sharp tip.

■ Cleaning the Unit

If the front panel of this unit is stained, wipe it with a dry soft cloth such as a silicon cloth. If the front panel is stained badly, wipe the stain off with a cloth moistened with neutral cleaner, then wipe it again with a clean soft dry cloth.

▲CAUTION

- Applying spray cleaner directly to the unit may affect its mechanical parts. Wiping the front panel with a hard cloth or using a volatile liquid such as thinner or alcohol may scratch the surface or erase screened print.

■ How to reset your unit

If the unit or the connected unit fails to operate properly, reset the unit.

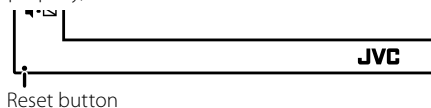

Reset button

Getting Started

1 Turn the ignition key of your car to ACC.

The unit is turned on.

2 Press the <Home> button.

3 Touch [Setting].



4 Touch the corresponding key and set the value.

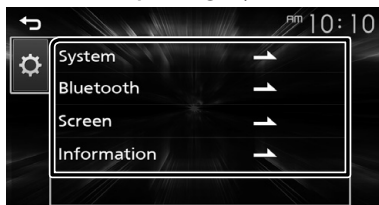

[System]

[Beep Tone]

Activates or deactivates the key-touch tone.
"ON" (Default), "OFF"

[Language]

Select the language used for the control screen and setting items. Default is "English".

[Time/Date]

Adjust the clock time. (P.3)

[Clock Mode]

Select the time display format.
[12hr] (Default) / [24hr]

[Steering Remote]

Sets the desired function in the steering remote controller. See **Learning function of steering remote (P.14)**.

[Parking Guidelines]

You can display parking guidelines to enable easier parking when you shift the gear to the reverse (R) position. Default is "ON".

[Guidelines SETUP]

If you select [ON] for [Parking Guidelines], you can adjust the parking guidelines. See **To adjust the parking guidelines (P.14)**.

[System Reset]

Touch [System Reset] and then touch [YES] to set all the settings to the initial default settings.

[Bluetooth]

Displays the Bluetooth Settings screen. (P.15)

[Screen]

[Dimmer]

Select the dimmer mode.
"High" (Default) / "Mid" / "Low"

[Demo]

Select the demonstration mode. Default is "ON".

[Information]

Displays the software version of this unit.

5 Touch [↵].

Clock settings

■ Synchronizing the clock time with FM RDS

Activate [RDS Clock Sync].
See **Tuner Setup (P.7)**.

■ Adjusting the clock manually

📌 NOTE

- Deactivate [RDS Clock Sync] before adjusting the clock.

1 Press the <Home> button.

2 Touch [Setting].

3 Touch [System].

4 Touch [Time/Date].

Clock screen appears.

5 Touch [▲] or [▼] to set the clock time.

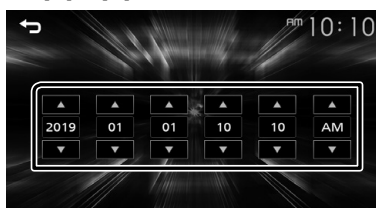

6 Touch [↵].

Basics

Functions of the Buttons on the Front Panel

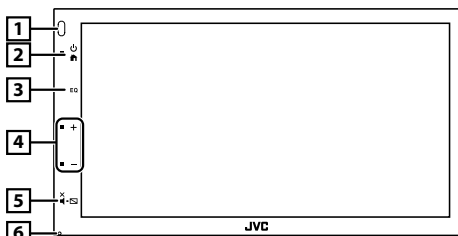

1 Remote Sensor

- Receives the remote control signal.

2 (HOME)

- Displays the HOME screen. **(P.5)**
- Pressing for 1 second turns the power off.
- When the power off, turns the power on.

3 EQ

- Displays the Audio screen.* **(P.18)**
- * The Audio screen is not displayed during SETUP screen or on the list screen etc.

4 +, - (Volume)

- Adjusts volume. The volume will go up until 20 when you keep pressing [+].

5 (MUTE, Display off)

- Mutes/restores the sound.
- Pressing for 1 second turns the screen off.
- When the screen is off, touch the display to turn on the screen.

6 Reset

- If the unit or the connected unit fails to operate properly, the unit returns to factory settings when this button is pressed.

Common operations

Turning on the power

- 1 Press the  button.





Turning off the power

- 1 Press and hold the  button.



Adjusting the volume

- 1 Press the  or  button.

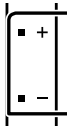

NOTE

- The volume will go up until 20 when you keep pressing [+].

Mutes the sound

- 1 Press the  button.

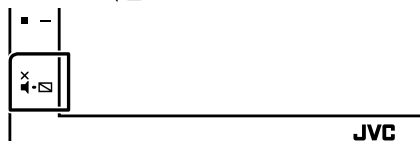

- To restore the sound, touch the button again, or adjust the volume.

Turn off the screen

- 1 Press and hold the  button.



- To turn on the screen, touch the display.

Basics



HOME screen descriptions

1 Press the  button.



HOME screen appears.



- 1 Clock display
Touch to displays the Clock screen.
- 2 Switches to the Tuner broadcast. **(P.6)**
- 3 **[USB]** 
Plays files on a USB device. **(P.8)**
[iPod] 
Plays an iPod/iPhone. **(P.10)**
 - When iPod/iPhone is connected.**[Mirroring]** 
Displays the Mirroring screen. **(P.12)**
 - When android device with "Mirroring OB for JVC" application installed is connected.
- 4 Switches to an external component connected to the AV-IN input terminal. **(P.13)**
- 5 Displays the Hands Free screen. **(P.16)**
- 6 Plays a Bluetooth audio player. **(P.17)**
- 7 Displays the SETUP screen. **(P.3)**

List screen

There are some common function keys in the list screens of most sources.

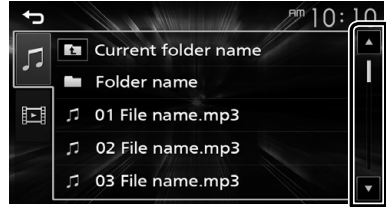

1 You can change the page to display more items by pressing **[▲]**/**[▼]**.

Tuner

Tuner Basic Operation

1 Press the <🏠> button.

2 Touch [Tuner].

Source control screen

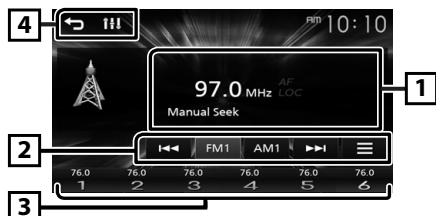

1 Displays the information of the current station:
PS name, Frequency, PTY Genre, Indicator Items

2 **[FM]**: Switches the FM band.

"FM1", "FM2", "FM3"

[AM]: Switches the AM band.

"AM1", "AM2"

[◀◀] [▶▶]: Tunes in a station with good reception automatically.

[☰]: Displays the Tuner Setup screen. **(P.7)**

3 Recalls the memorized station.

When touched for 2 seconds, stores the current receiving station in memory.

4 **[🏠]**: Returns to previous screen.

[🔊]: Displays the Audio screen. **(P.18)**

Presetting stations

Auto memory

You can preset 6 stations for the current band (FM1/FM2/FM3/AM1/AM2).

1 Touch [FM] or [AM] to select the band.

2 Touch [☰].

3 Touch [Auto Store].

The local stations with the strongest signals are found and stored automatically.

Manual memory

You can store the current receiving station in memory.

1 Tune in to a station you want to preset.

2 Touch and hold [#] (#:1-6) in which you want to store the station.

Recalling the preset station

1 Touch [#] (#:1-6).

Tuner

Tuner Setup

1 Touch [].

2 Set each item as follows.



[Auto Store]

Automatically searches and stores the 6 stations with the strongest signals for the selected band.

"Auto Store" appears.

[Area]

"N.America" (Default): For North/Central/South America, AM/FM intervals: 10 kHz/200 kHz.

"S.America": For some South American countries, AM/FM intervals: 10 kHz/50 kHz.

"Europe": For Europe, AM/FM intervals: 9 kHz/50 kHz.

[Local Seek]

Tunes in only to the stations with sufficient signal strength. (**LOC** indicator lights up.)

"ON", "OFF" (Default)

[RDS Clock Sync] *1 *2

Synchronizing the Radio Data System station time data and this unit's clock.

"ON" (Default), "OFF"

[RDS] *2 *3

Displays the RDS Settings screen.

[AF]

When station reception is poor, automatically switches to the station that is broadcasting the same program over the same Radio Data System network.

"ON" (Default), "OFF"

[TA]

Switches to the traffic information automatically when the traffic bulletin starts. (**TI** indicator lights up.)

"ON", "OFF" (Default)

[RDS Clock Sync]

Synchronizing the Radio Data System station time data and this unit's clock.

"ON" (Default), "OFF"

[PTY]

Select a program type.

[PTY Seek]

Searches for a program by program type.

*1 To use the function, it is necessary to set [Area] to [N.America]/[S.America].

*2 To use the function, it is necessary to set [Area] to [Europe].

*3 FM only

3 Touch [].

USB

Preparation

■ Connecting a USB device

- 1 Remove the cap of the USB terminal.
- 2 Connect the USB device with the USB cable.

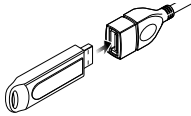

The unit reads the device and playback starts.

■ To disconnect the USB device:

- 1 Press the <Home> button.
- 2 Touch a source other than [USB].
- 3 Detach the USB device.

■ Usable USB device

This unit can play MPEG1/ MPEG2/ MPEG4/ H.264/ MKV/ MP3/WMA/ AAC/ WAV/ FLAC/ OGG files stored in a USB mass storage class device. **(P.26)**

- File system: FAT16/ FAT32/ NTFS
- This unit can recognize a total of 9 999 files and 320 folders (a maximum of 9 999 files per folder).
- The maximum number of characters:
 - Folder names : 70 characters
 - File names : 70 characters
 - Tag : 70 characters

📎 NOTE

- When the USB device is connected to this unit, it can be charged through the USB cable.
- Install the USB device in the place where it will not affect safe driving.
- You cannot connect a USB device via a USB hub and Multi Card Reader.
- Take backups of the audio files used with this unit. The files may be erased depending on the operating conditions of the USB device.
We shall have no compensation for any damage arising from any erased data.
- No USB device comes with this unit. You need to purchase a commercially available USB device.
- Cap the USB terminal whenever not using.

Playback operations

■ Control the music you are listening to on the source control screen.

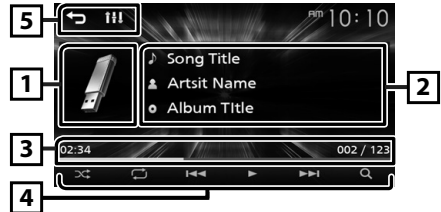

- 1 The jacket of the currently playing file is displayed.
- 2 Displays the information of the current file.
- 3 Playing time/File number
Play time bar : For confirmation of current playing position.
- 4 [⌘] : Selects Random playback mode.
 - ⌘ : Randomly plays all files in the current folder.
 - ⌘ (Default): Normal playback.[🔄] : Selects Repeat playback mode.
 - 🔄 (Default): Repeats all files in the USB device.
 - 🔄 : Repeats the current file.
 - 🔄 : Repeats all files in the current folder.[▶], [⏸] : Plays or pauses.
[⏮], [⏭] : Searches the previous/next content.
Touch and hold to fast forward or fast backward.
[🔍] : Searches file. **(P.9)**
- 5 [⏪] : Returns to previous screen.
[📁] : Displays the Audio screen. **(P.18)**

■ For Video playback

1 When the operation buttons are not displayed on the screen, touch the display.



1 : You can adjust image quality in video screen.

[Brightness]: Adjusts the brightness. (00 to 10)

[Contrast]: Adjusts the contrast. (00 to 10)

[Color]: Adjusts the color. (00 to 10)

[Tint]: Adjusts the tint. (00 to 10)

[INITIALIZE]: To clear the adjustment.

2 Playing time

Play time bar: For confirmation of current playing position.

3 , : Plays or pauses.

, : Searches the previous/next content.

Touch and hold to fast forward or fast backward.

[Q]: Searches file. **(P.9)**

[NORMAL]/[16:9]/[4:3]: Select a screen mode.

4 : Returns to previous screen.

: Displays the Audio screen. **(P.18)**

■ Selecting a track in a list (Searches file)

1 Touch [Q].

2 Select whether you search by audio files , video files .



3 Touch to moves to the upper hierarchy.

4 Touch the desired folder.

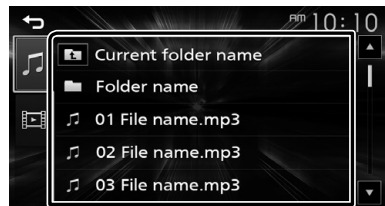

When you touch a folder its contents are displayed.

- Touch to moves to the upper hierarchy.

5 Touch desired item from the content list.

Playback starts.

📎 NOTE

- The source control screen appears when you touch at the top hierarchy.

iPod/iPhone

Preparation

■ Connecting iPod/iPhone

- For Lightning connector models: Use USB Audio cable for iPod/iPhone—KS-U62 (optional accessory).
- For details about connecting iPod/iPhone, see page 25 .

1 Remove the cap of the USB terminal.

2 Connect the iPod/iPhone.

The unit reads the device and playback starts.

■ To disconnect the iPod/iPhone

1 Press the <Home> button.

2 Touch a source other than [iPod].

3 Detach the iPod/iPhone.

■ Connectable iPod/iPhone

The following models can be connected to this unit.

Made for

- iPhone XS Max
- iPhone XS
- iPhone XR
- iPhone X
- iPhone 8 Plus
- iPhone 8
- iPhone 7 Plus
- iPhone 7
- iPhone SE
- iPhone 6s Plus
- iPhone 6s
- iPhone 6 Plus
- iPhone 6
- iPhone 5s

📎 NOTE

- If you start playback after connecting the iPod, the music that has been played by the iPod is played first.
- Cap the USB terminal whenever not using.

Playback operations

■ Control the music you are listening to on the source control screen.

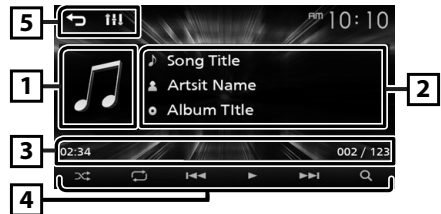

1 Artwork (Shown if the track contains artwork)

2 Displays the information of the current file.

3 Playing time/File number

Play time bar : For confirmation of current playing position.

4 [] : Selects Random playback mode.

[] : Functions the same as Shuffle Songs.

[] : Random off

[] : Selects Repeat playback mode.

[] : Functions the same as Repeat All.

[] : Functions the same as Repeat One.

[] : Repeat off

[▶], [⏸] : Plays or pauses.

[⏮], [⏭] : Searches the previous/next content.

Touch and hold to fast forward or fast backward.

[🔍] : Searches content. **(P.11)**

5 [⏪] : Returns to previous screen.

[⏮] : Displays the Audio screen. **(P.18)**

iPod/iPhone

■ Selecting a content in a list

1 Touch [Q].

2 Touch desired item.

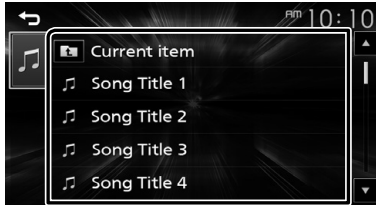

When you touch a category its contents are displayed.

3 Touch desired item from the content list.

Playback starts.

- Touch [↶] to moves to the upper hierarchy.

📎 NOTE

- The source control screen appears when you touch [↶] at the top hierarchy.

Mirroring

Preparation

You can display and control the App on the unit while your smartphone is connected to the USB terminal.

NOTE

- Pair your smartphone with the unit via Bluetooth. See **Register your smartphone to the unit (P.15)** and Connect the Bluetooth device.

Compatible Android smartphone

- Android version 7.0 or later
- Bluetooth support

NOTE

- This unit may not work for some Android smartphone's.

Connecting Android smartphone

1 Download Mirroring App from Google Play.

Install the latest version of the Mirroring application "Mirroring OB for JVC" on your Android.

2 Remove the cap of the USB terminal.

3 Connect the Android smartphone. (P.25)

4 Launch Mirroring App on your Android Smartphone.

- 1) Touch to check mark.

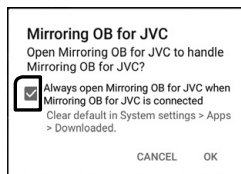

- 2) Touch "OK" to start Mirroring App.
- 3) Touch to check mark.

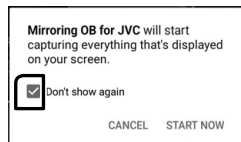

- 4) Touch "START NOW" to start capturing your Android screen.

5 Start to enjoy Mirroring.

To disconnect the Android smartphone

1 Press the button.

2 Touch a source other than [Mirroring].

3 Detach the Android smartphone.

Mirroring operations

Mirroring Operation

1 Touch [Mirroring].



- You can display the same screen of the Android device on the monitor of the unit.

To turn off the Mirroring

1 Press the button.



- HOME screen appears.

External Components

Using external audio/video players

Starting playback

- 1 Connect an external component to the AV-IN input terminal. (P.24)
- 2 Press the button.
- 3 Touch [AV-IN].
- 4 Turn on the connected component and start playing the source.

For Video playback

- 1 When the operation buttons are not displayed on the screen, touch the display.

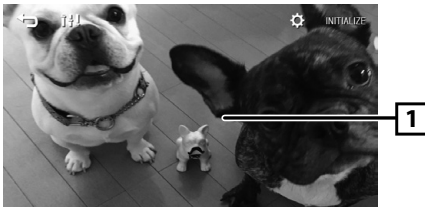

NOTE

- When the picture from the rear view camera is displayed on the AV-IN screen, the picture output from the Visual Output terminal disappears.

Rear view camera

To use a rear view camera, the REVERSE lead connection is required. For connecting a rear view camera. (P.24)

Displaying the picture from the rear view camera

The rear view screen is displayed when you shift the gear to the reverse (R) position.



- To erase the caution message, touch the screen.

External Components

To adjust the parking guidelines

NOTE

- Install the rear view camera in the appropriate position according to the instruction manual supplied with the rear view camera.
- When adjusting the parking guidelines, make sure to apply the parking brake to prevent the car from moving.

1 Press the <> button.

2 Touch [Setting].

3 Touch [System].

4 Touch [◀] or [▶] of [Parking Guidelines] and set to [ON].

5 Touch [Guidelines SETUP].

6 Adjust the parking guidelines by selecting the [] mark.



7 Adjusting the position of the selected mark.

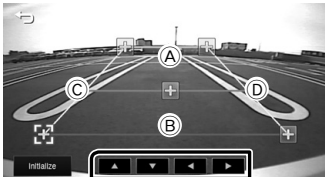

Make sure that lines A and B are horizontally parallel, and that lines C and D are of the same length.

NOTE

- Touch [Initialize] and then touch [Yes] to set all the marks to their initial default position.

Learning function of steering remote

This function is available only when your vehicle is equipped with the electrical steering remote controller.

1 Press the <> button.

2 Touch [Setting].

3 Touch [System].

4 Touch [Steering Remote].

5 Touch the function you want to set.

6 Press and hold the steering remote controller button.

NOTE

- You can have the unit learned all buttons at a time. In that case, press the all buttons one at a time and after pressing all of them, touch [] in Steering Remote Controller Setting screen.

7 Repeat steps 5 and 6 as necessary.

8 Touch [].

NOTE

- Touch [Initialize] and then touch [Yes] to set all the settings to the initial default settings.

Bluetooth

About the Bluetooth smartphone and Bluetooth audio player

This unit conforms to the following Bluetooth specifications:

Version

Bluetooth Ver.4.2

Profile

Smartphone/ Cell-phone:

HFP (V1.6) (Hands Free Profile)

PBAP (Phonebook Access Profile)

Audio player:

A2DP (Advanced Audio Distribution Profile)

AVRCP (V1.5) (Audio/Video Remote Control Profile)

Sound codec

SBC

About mobile phones compatible with Phone book Access Profile (PBAP)

If your mobile phone supports PBAP, you can display the following items on the touch panel screen when the mobile phone is connected.

- Phone book (up to 1000 entries)
- Dialed calls, received calls, and missed calls (up to 50 entries in total)

Register your smartphone to the unit

You can use your Bluetooth smartphone when paired to this unit.

You can register up to 8 Bluetooth devices.

- You can pair the device and the unit using SSP (Secure Simple Pairing) which only requires confirmation.
- One device can be connected at a time.
- When you register a new Bluetooth device, disconnect the Bluetooth device currently connected and then register the new device.
- A new device cannot be registered if there are 8 registered Bluetooth units. Delete unnecessary registration. **(P.15)**

1 Turn on the Bluetooth function on your smartphone/cell-phone.

2 Search the unit ("KW-M150BT") from your smartphone/cell-phone.

If a PIN code is required, enter the PIN code ("0000").

-  appears when the Bluetooth smartphone is connected.

Disconnecting the device

- Turn off the Bluetooth function from your smartphone/cell-phone.
- Turn off the ignition switch.

Bluetooth Setup

1 Press the button.

2 Touch [Setting].

3 Touch [Bluetooth].

4 Touch the corresponding key and set the value.

[Select Device]

Connect the Bluetooth device.

[Phone Auto Answer]

Set the automatic response time to pick-up an incoming call.

"OFF" (Default) / "ON"

[Device Name]

The Bluetooth device name of this unit is displayed.

[Pin Code]

Displays the PIN code.

[Device address]

Displays the device address.

Connect the Bluetooth device

1 Touch [Select Device] on the Bluetooth Setup screen.

2 Touch [] of the device you want to connect.

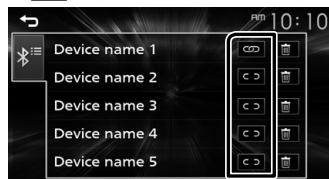

To delete the registered Bluetooth device

1 Touch [] on the Select Device screen.

Bluetooth

Receive a phone call

1 Touch [Phone].

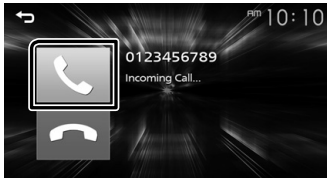

- [Phone]: Reject an incoming call.

Operations during a call

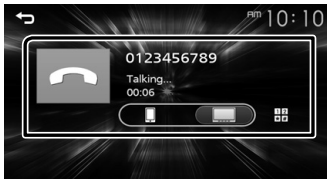

[Phone] Ending a call

[1 2] [x #] You can send tones by touching desired keys on the screen.

- Touch [Back] to close the window.

[Smartphone/Cellphone] [Speaker] Switches the speaking voice output between smartphone/cell-phone and speaker.

- **Adjust the receiver volume**
Press the <+> or <-> button.

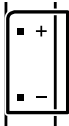

Make a phone call

1 Press the <Home> button.

2 Touch [Phone].

3 See the table below for each operation method.



Call by entering a phone number

1) Enter a phone number with number keys.

2) Touch [Phone].

Make a call

- Touch [X] to delete the last entry.

Call using call records

1) Touch [Phone].

2) Touch [Incoming Calls], [Outgoing Calls], [Missed Calls].

3) Select the phone number from the list.

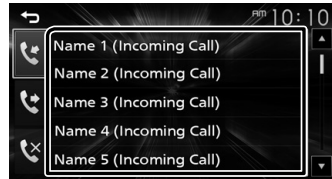

Make a call

Call using the phonebook

1) Touch [Phone].

2) Select the name from the list.



Make a call

- [Phone]: Updates the phonebook. Touch this button after you have made a change to the phonebook of your smartphone/cell-phone.

Bluetooth

Call by voice

You can make a voice call using the voice recognition function of the Bluetooth smartphone.

- 1) Touch [🗨️].
- 2) Say the name registered in the Bluetooth smartphone.



- Touch [Cancel] to cancel voice dialing.

Playing Bluetooth Audio Device

1 Press the <🏠> button.

2 Touch [BT Audio].

Source control screen

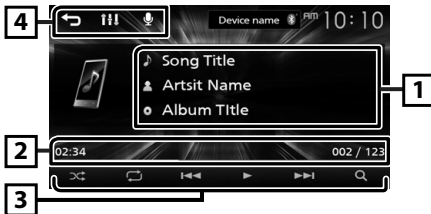

1 Displays the information of the current file.

2 Playing time/File number

Play time bar : For confirmation of current playing position.

3 [🔀] : Selects Random playback mode.

[🔀] : Randomly plays all files.

[🔀] : Random off

[🔁] : Selects Repeat playback mode.

[🔁] : Repeats all files.

[🔁] : Repeats the current file.

[🔁] : Repeat off

[▶], [⏸] : Plays or pauses.

[⏮], [⏭] : Searches the previous/next content.

Touch and hold to fast forward or fast backward.

[🔍] : Searches file. **(P.17)**

4 [🏠] : Returns to previous screen.

[🔊] : Displays the Audio screen. **(P.18)**

[🗨️] : Displays the Voice Recognition screen.*

NOTE

- Operations and display indications may differ according to their availability on the connected device.
- * You can access the voice recognition function of the Bluetooth smartphone connected to this unit. (The functionality depends on the Bluetooth smartphone.)

Selecting a content in a list

1 Touch [Q].

2 Touch desired item.



When you touch a category its contents are displayed.

3 Touch desired item from the content list.

Playback starts.

- Touch [⏮] to moves to the upper hierarchy.

NOTE

- The source control screen appears when you touch [🏠] at the top hierarchy.

Controlling Audio

You can adjust various settings such as audio balance or subwoofer level.

- 1 Press the <EQ> button.
- 2 See the below for each operation method.



Controlling General Audio

- 1 Press the <EQ> button.
- 2 Touch [Fader / Balance].
- 3 Set each item as follows.

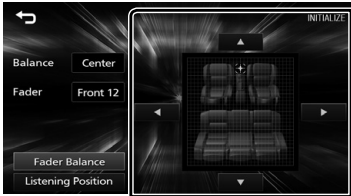

[Fader Balance]

Balance Adjust the left and right volume balance.
 [▶][◀]
 15 (right) to 15 (left)

Fader Adjust the front and rear volume balance.
 [▲][▼]
 15 (front) to 15 (rear)

[INITIALIZE] To clear the adjustment.

[Listening Position]

[●] Select a listening position from "Front Left", "Front All", "Front Right", and "Middle".

[INITIALIZE] To clear the adjustment.

Equalizer Control

- 1 Press the <EQ> button.
- 2 Touch [Equalizer].
- 3 Set each item as follows.

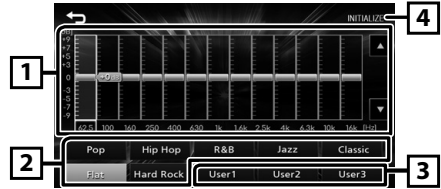

- 1 You can select frequency bar and adjust its level. (-9 to +9)
 • The adjustments are stored.
- 2 To recall the preset equalizer curve.
- 3 Recalls the memorized EQ curve.
- 4 Initialize the current EQ curve.

Controlling Audio

Speaker / X'Over setup

- 1 Press the <EQ> button.
- 2 Touch [Speaker / X'Over].
- 3 Touch the speaker to set up.

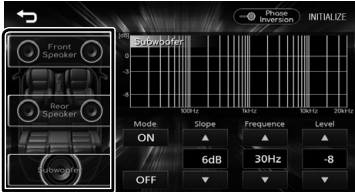

4 Set each item as follows.

Mode [OFF], [ON]	[ON]: Filter adjustment. [OFF]: Turns off the filter.
Slope [▲][▼]	Set a crossover slope.
Frequency [▲][▼]	<ul style="list-style-type: none"> • High Pass Filter adjustment. (When Front or Rear is selected) • Low Pass Filter adjustment. (When Subwoofer is selected)
Level [▲][▼]	Adjust the gain of the front speaker, rear speaker, or subwoofer.
Phase Inversion	Set the phase of subwoofer output. [] to shift the phase 180 degrees. (When Subwoofer is selected)
[INITIALIZE]	To clear the adjustment.

Listening Position / DTA

- 1 Press the <EQ> button.
- 2 Touch [Position / DTA].
- 3 Touch [Delay].
- 4 Touch [◀] or [▶] to adjust the delay time of the selected speaker.

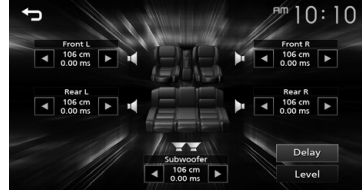

- 5 Touch [Level].
- 6 Touch [◀] or [▶] to adjust the sound level of the selected speaker.

Sound Effect

- 1 Press the <EQ> button.
- 2 Touch [Sound Effect].
- 3 Set each item as follows.

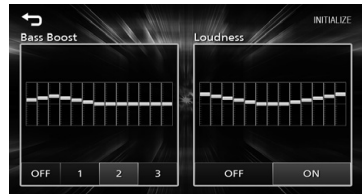

- | | |
|---|--|
| Bass Boost
[OFF], [1], [2], [3] | Set the amount of bass boost |
| Loudness
[OFF], [ON] | Set the amount of boost of low and high tones. |
| [INITIALIZE] | To clear the adjustment. |

Remote control

This unit can be operated using the remote control. The remote control RM-RK258 (optional accessory) can be used.

Functions of the Remote control Buttons

- Aim the remote control directly at the remote sensor on the faceplate.
- DO NOT expose the remote sensor to bright light (direct sunlight or artificial lighting).

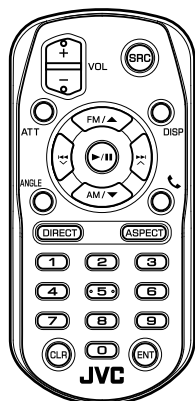

SRC	Switches to the source to be played.
VOL + -	Adjusts the volume.
ATT	Mutes/restores the sound
DISP	Not used.
FM/▲	Selects the folder to be played.
AM/▼	During tuner source, select FM/ AM band to be received.
◀◀ ◻	During tuner source, switches to broadcast stations received by the unit.
▶▶ ▲	During tuner source, switches to broadcast stations received by the unit.
ANGLE	Not used.
☎	When a call comes in, answers the call.
DIRECT	Not used.
ASPECT	Not used.
Numeric Keypad	Not used.
CLR	Clears the telephone number input on the Phone screen.
ENT	Not used.

Installation

Before Installation

Before installation of this unit, please note the following precautions.

▲WARNINGS

- If you connect the ignition wire (red) and the battery wire (yellow) to the car chassis (ground), you may cause a short circuit, that in turn may start a fire. Always connect those wires to the power source running through the fuse box.
- Do not cut out the fuse from the ignition wire (red) and the battery wire (yellow). The power supply must be connected to the wires via the fuse.

▲CAUTION

- Install this unit in the console of your vehicle. Do not touch the metal part of this unit during and shortly after the use of the unit. Metal part such as the heat sink and enclosure become hot.

🔧 NOTE







- Mounting and wiring this product requires skills and experience. For best safety, leave the mounting and wiring work to professionals.
- Make sure to ground the unit to a negative 12V DC power supply.
- Do not install the unit in a spot exposed to direct sunlight or excessive heat or humidity. Also avoid places with too much dust or the possibility of water splashing.
- Do not use your own screws. Use only the screws provided. If you use the wrong screws, you could damage the unit.
- If your car's ignition does not have an ACC position, connect the ignition wires to a power source that can be turned on and off with the ignition key. If you connect the ignition wire to a power source with a constant voltage supply, such as with battery wires, the battery may be drained.
- If the console has a lid, make sure to install the unit so that the front panel will not hit the lid when closing and opening.
- If the fuse blows, first make sure the wires aren't touching to cause a short circuit, then replace the old fuse with one with the same rating.
- Insulate unconnected wires with vinyl tape or other similar material. To prevent a short circuit, do not remove the caps on the ends of the unconnected wires or the terminals.
- Secure the wires with cable clamps and wrap vinyl tape around the wires that comes into contact with metal parts to protect the wires and to prevent short circuit.

- Connect the speaker wires correctly to the terminals to which they correspond. The unit may be damaged or fail to work if you share the ⊖ wires or ground them to any metal part in the car.
- When only two speakers are being connected to the system, connect the connectors either to both the front output terminals or to both the rear output terminals (do not mix front and rear). For example, if you connect the ⊕ connector of the left speaker to a front output terminal, do not connect the ⊖ connector to a rear output terminal.
- After the unit is installed, check whether the brake lamps, blinkers, wipers, etc. on the car are working properly.
- Mount the unit so that the mounting angle is 30° or less.
- Do not press hard on the panel surface when installing the unit to the vehicle. Otherwise scars, damage, or failure may result.
- Reception may drop if there are metal objects near the Bluetooth antenna.

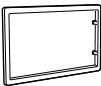

Installation

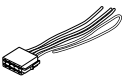
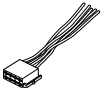
■ Supplied accessories for installation

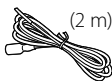
①		x1	②		x2
③		x1	④		x1
⑤		x1	⑥		x1
⑦		x6	⑧		x6
⑨		x1			

■ Installation procedure

- 1) To prevent a short circuit, remove the key from the ignition and disconnect the \ominus terminal of the battery.
- 2) Make the proper input and output wire connections for each unit.
- 3) Connect the wire on the wiring harness.
- 4) Take Connector B on the wiring harness and connect it to the speaker connector in your vehicle.
- 5) Take Connector A on the wiring harness and connect it to the external power connector on your vehicle.
- 6) Connect the wiring harness connector to the unit.
- 7) Install the unit in your car.
- 8) Reconnect the \ominus terminal of the battery.
- 9) Press the reset button.

Installing the unit

■ Non-Japanese cars

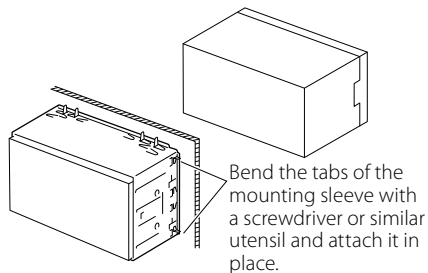

NOTE

- Make sure that the unit is installed securely in place. If the unit is unstable, it may malfunction (eg, the sound may skip).

■ Japanese cars (North America, South America sales area only)

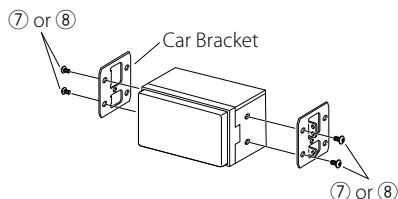

■ Trim plate

- 1) Attach accessory ① to the unit.

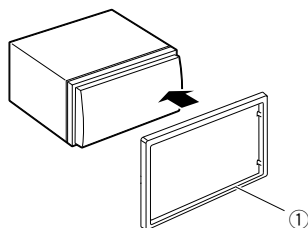

Installation

Microphone unit

- 1) Check the installation position of the microphone (accessory ④).
- 2) Clean the installation surface.
- 3) Remove the separator of the microphone (accessory ④), and stick the microphone to the place shown below.
- 4) Wire the microphone cable up to the unit with it secured at several positions using tape or other desired method.
- 5) Adjust the direction of the microphone (accessory ④) to the driver.

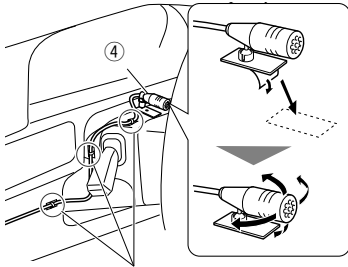

Fix a cable with a commercial item of tape.

NOTE

- Swap the clips if necessary.

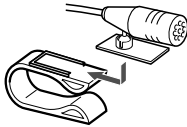

Removing the trim plate

- 1) Use the extraction key (accessory ③) to lever out the four tabs (two on the left part, two on the right part).

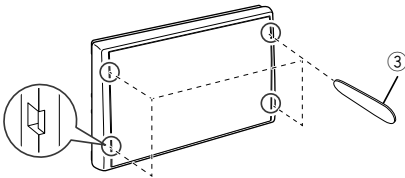

- 2) Pull the trim plate forward.

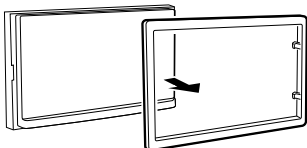

Removing the unit

- 1) Remove the trim plate by referring to step 1 in "Removing the trim plate".
- 2) Insert the extraction key (accessory ②) deeply into the slot as shown. (The protrusion at the tip of the extraction key must face toward the unit.)

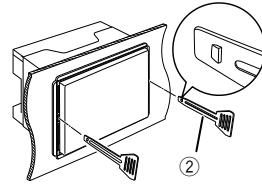

- 3) With the inserted extraction key secured, insert the other extraction key into the slot.

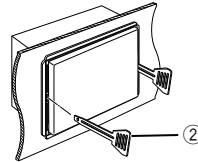

- 4) Pull out the unit halfway.

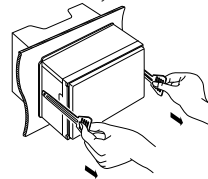

NOTE

- Be careful to avoid injury from the catch pins on the extraction key.
- 5) Pull the unit all the way out with your hands, being careful not to drop it.

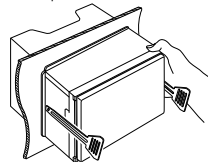

Installation

■ Connecting wires to terminals

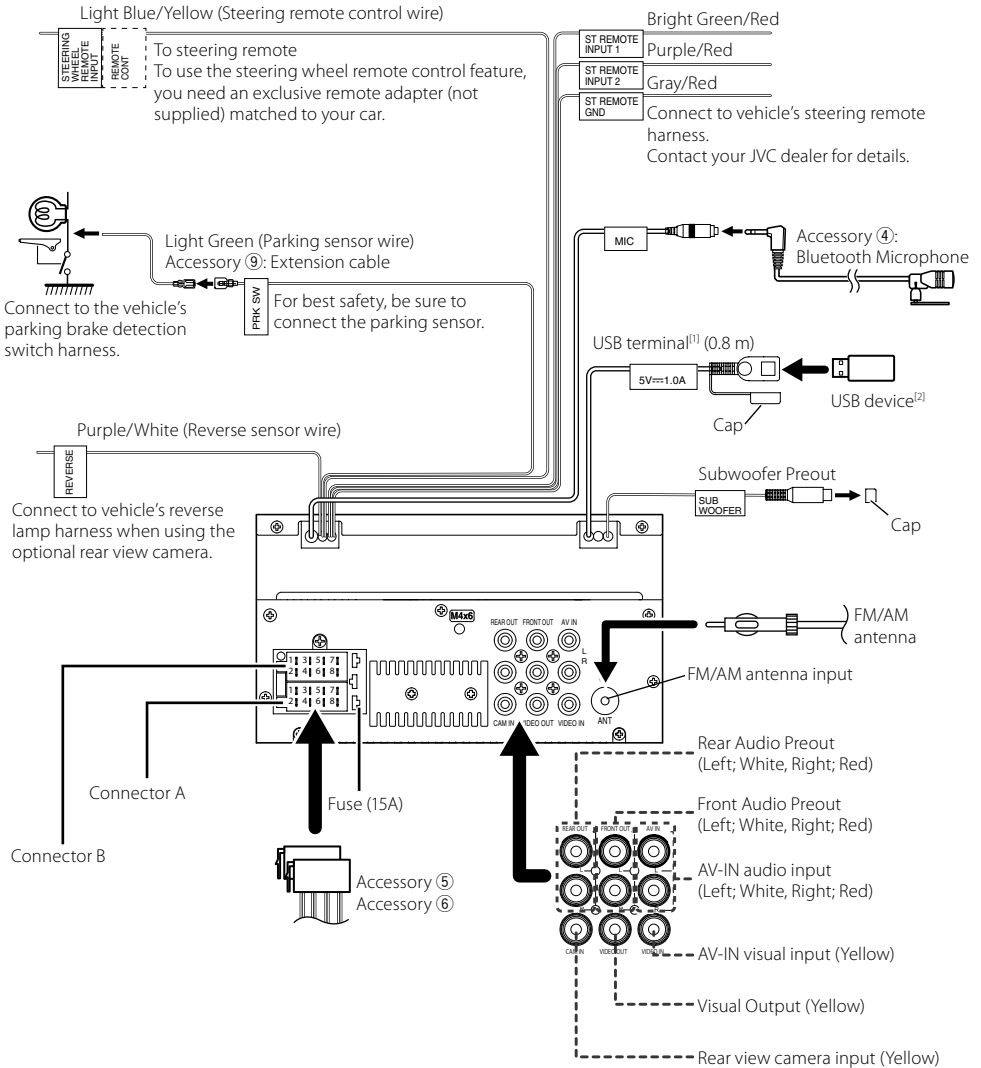

^[1] USB maximum power supply current :
DC 5 V = 1.0 A

^[2] Sold separately

Installation

■ Connecting an iPod/iPhone/Android

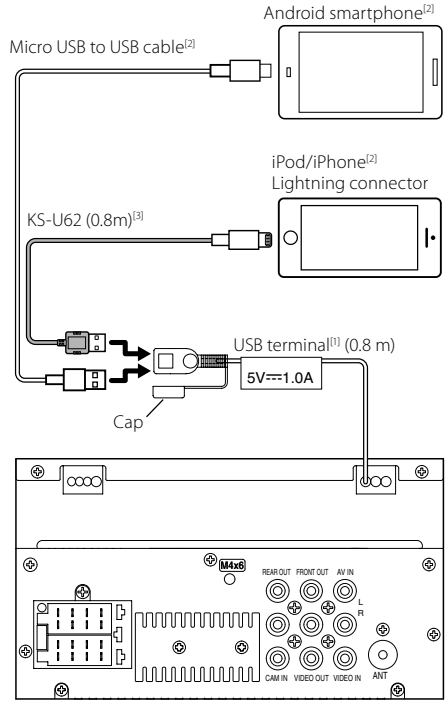
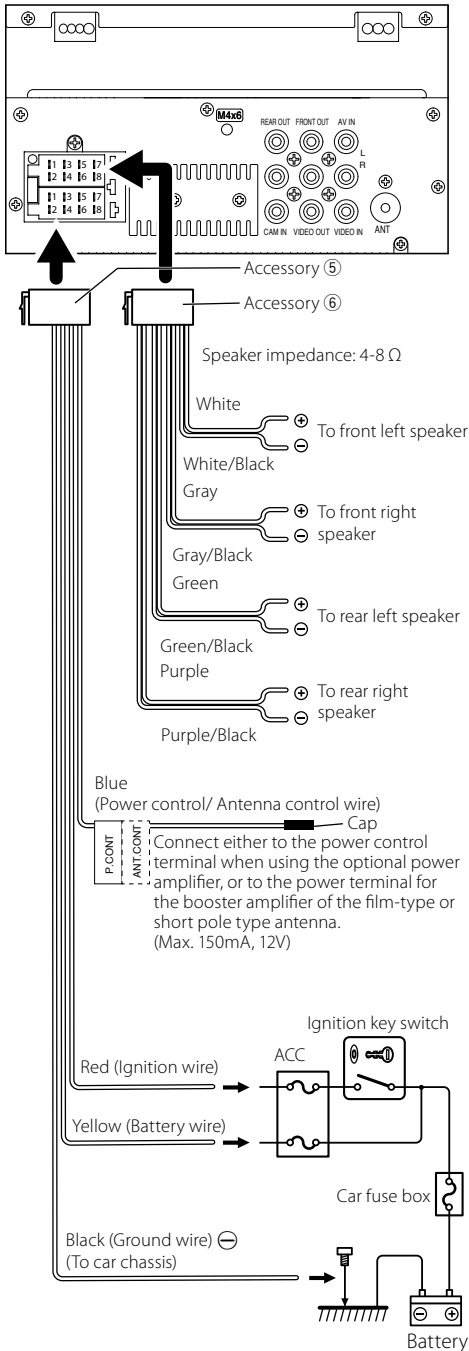

^[1] USB maximum power supply current :

DC 5 V --- 1.0 A

^[2] Sold separately

^[3] Optional accessory

About this Unit

More information

▶ Playable Audio files

Audio format	Bit rate/ (Bit count)	Sampling frequency
MP3 (.mp3)	16 – 320kbps, VBR	16 – 48 kHz
WMA (.wma)	16 – 320kbps	16 – 48 kHz
AAC-LC (.m4a, .aac)	16 – 320kbps	16 – 48 kHz
Linear PCM (WAVE) (.wav)	(16/24 bit)	8 – 192 kHz
FLAC (.flac)	(16/24 bit)	8 – 192 kHz
Vorbis (.ogg)	(16/24 bit)	8 – 192 kHz

- This unit can show ID3 Tag Version 1.0/1.1/2.2/2.3/2.4 (for MP3).
- The maximum number of characters:
 - Tag : 70 characters

🔧 NOTE

- WMA and AAC of which is covered with DRM cannot be played.
- Although the audio files are complied with the standards listed above, the play may be impossible depending on the types or conditions of media or device.

▶ Acceptable Video files

Video format	Video codec	Audio codec
MPEG-1 (.mpg, .mpeg)	MPEG-1	MPEG Audio Layer 2
MPEG-2 (.mpg, .mpeg)	MPEG-2	MPEG Audio Layer 2
MPEG-4 (.mp4, .avi)	MPEG-4 (SP,ASP)	MP3, AAC-LC (2ch)
H.264/MPEG-4 AVC (.mp4, .mkv, .avi, .flv, .f4v, .ts)	H.264/MPG-4 AVC (BP/MP/HP)	MP3, AAC (2ch)
MKV (.mkv)	Video Format follows H.264/ MPEG-4 AVC, MPEG4, XVID	MP3, AAC, Vorbis, FLAC

Troubleshooting

What appears to be trouble is not always serious. Check the following points before calling a service center.

- For operations with the external components, refer also to the instructions supplied with the adapters used for the connections (as well as the instructions supplied with the external components).

▶ General

No sound comes out of the speakers.

- Adjust the volume to the optimum level.
- Check the cords and connections.

The unit does not work at all.

- Reset the unit. (P.2)

The remote controller does not work.

- Replace the battery.

▶ USB

While playing a track, sound is sometimes interrupted.

- The tracks are not properly copied into the USB device. Copy the tracks again, and try again.

▶ iPod/iPhone

No sound comes out of the speakers.

- Disconnect the iPod/iPhone, then connect it again.
- Select another source, then reselect "iPod".

The iPod/iPhone does not turn on or does not work.

- Check the connecting cable and its connection.
- Update the firmware version of iPod/iPhone.
- Charge the battery of iPod/iPhone.
- Reset the iPod/iPhone.

Sound is distorted.

- Deactivate the equalizer either on this unit or the iPod/iPhone.

A lot of noise is generated.

- Turn off (uncheck) "VoiceOver" on the iPod/iPhone. For details, visit <<http://www.apple.com>>.

▶ Tuner

Automatic presetting does not work.

- Store stations manually. (P.6)

Static noise while listening to the radio.

- Connect the antenna firmly.

About this Unit

AV-IN

No picture appears on the screen.

- Turn on the video component if it is not on.
- Connect the video component correctly.

Bluetooth

Phone sound quality is poor.

- Reduce the distance between the unit and the Bluetooth mobile phone.
- Move the car to a place where you can get a better signal reception.

The sound is interrupted or skipped while using a Bluetooth audio player.

- Reduce the distance between the unit and the Bluetooth audio player.
- Turn off, then turn on the unit. (When the sound is not yet restored) connect the player again.

The connected audio player cannot be controlled.

- Check whether the connected audio player supports AVRCP (Audio/Video Remote Control Profile).

The Bluetooth device does not detect the unit.

- Search from the Bluetooth device again.

The unit does not pair with the Bluetooth device.

- Turn off, then turn on the Bluetooth device.
- Disconnect the Bluetooth device currently connected and then register the new device. (P.15)

Copyrights

- The Bluetooth word mark and logos are registered trademarks owned by the Bluetooth SIG, Inc. and any use of such marks by JVC KENWOOD Corporation is under license. Other trademarks and trade names are those of their respective owners.
- Use of the Made for Apple badge means that an accessory has been designed to connect specifically to the Apple product(s) identified in the badge, and has been certified by the developer to meet Apple performance standards. Apple is not responsible for the operation of this device or its compliance with safety and regulatory standards. Please note that the use of this accessory with an Apple product may affect wireless performance.
- Apple, iPhone, iPod, iPod touch, and Lightning are trademarks of Apple Inc., registered in the U.S. and other countries.
- Microsoft and Windows Media are either registered trademarks or trademarks of Microsoft Corporation in the United States and/or other countries.
- THIS PRODUCT IS LICENSED UNDER THE MPEG-4 VISUAL PATENT PORTFOLIO LICENSE FOR THE PERSONAL AND NON-COMMERCIAL USE OF A CONSUMER FOR (i) ENCODING VIDEO IN COMPLIANCE WITH THE MPEG-4 VISUAL STANDARD ("MPEG-4 VIDEO") AND/OR (ii) DECODING MPEG-4 VIDEO THAT WAS ENCODED BY A CONSUMER ENGAGED IN A PERSONAL AND NON-COMMERCIAL ACTIVITY AND/OR WAS OBTAINED FROM A VIDEO PROVIDER LICENSED BY MPEG LA TO PROVIDE MPEG-4 VIDEO. NO LICENSE IS GRANTED OR SHALL BE IMPLIED FOR ANY OTHER USE. ADDITIONAL INFORMATION INCLUDING THAT RELATING TO PROMOTIONAL, INTERNAL AND COMMERCIAL USES AND LICENSING MAY BE OBTAINED FROM MPEG LA, LLC. SEE [HTTP://WWW.MPEGLA.COM](http://www.MPEGLA.COM).
- THIS PRODUCT IS LICENSED UNDER THE AVC PATENT PORTFOLIO LICENSE FOR THE PERSONAL USE OF A CONSUMER OR OTHER USES IN WHICH IT DOES NOT RECEIVE REMUNERATION TO (i) ENCODE VIDEO IN COMPLIANCE WITH THE AVC STANDARD ("AVC VIDEO") AND/OR (ii) DECODE AVC VIDEO THAT WAS ENCODED BY A CONSUMER ENGAGED IN A PERSONAL ACTIVITY AND/OR WAS OBTAINED FROM A VIDEO PROVIDER LICENSED TO PROVIDE AVC VIDEO. NO LICENSE IS GRANTED OR SHALL BE IMPLIED FOR ANY OTHER USE. ADDITIONAL INFORMATION MAY BE OBTAINED FROM MPEG LA, L.L.C. SEE [HTTP://WWW.MPEGLA.COM](http://www.MPEGLA.COM)
- libFLAC

Copyright (C) 2000-2009 Josh Coalson

Copyright (C) 2011-2013 Xiph.Org Foundation

- Redistribution and use in source and binary forms, with or without modification, are permitted provided that the following conditions are met:
- Redistributions of source code must retain the above copyright notice, this list of conditions and the following disclaimer.

About this Unit

– Redistributions in binary form must reproduce the above copyright notice, this list of conditions and the following disclaimer in the documentation and/or other materials provided with the distribution.

Neither the name of the Xiph.org Foundation nor the names of its contributors may be used to endorse or promote products derived from this software without specific prior written permission.

THIS SOFTWARE IS PROVIDED BY THE COPYRIGHT HOLDERS AND CONTRIBUTORS "AS IS" AND ANY EXPRESS OR IMPLIED WARRANTIES, INCLUDING, BUT NOT LIMITED TO, THE IMPLIED WARRANTIES OF MERCHANTABILITY AND FITNESS FOR A PARTICULAR PURPOSE ARE DISCLAIMED. IN NO EVENT SHALL THE FOUNDATION OR CONTRIBUTORS BE LIABLE FOR ANY DIRECT, INDIRECT, INCIDENTAL, SPECIAL, EXEMPLARY, OR CONSEQUENTIAL DAMAGES (INCLUDING, BUT NOT LIMITED TO, PROCUREMENT OF SUBSTITUTE GOODS OR SERVICES; LOSS OF USE, DATA, OR PROFITS; OR BUSINESS INTERRUPTION) HOWEVER CAUSED AND ON ANY THEORY OF LIABILITY, WHETHER IN CONTRACT, STRICT LIABILITY, OR TORT (INCLUDING NEGLIGENCE OR OTHERWISE) ARISING IN ANY WAY OUT OF THE USE OF THIS SOFTWARE, EVEN IF ADVISED OF THE POSSIBILITY OF SUCH DAMAGE.

• libogg

Copyright (c) 2002, Xiph.org Foundation Redistribution and use in source and binary forms, with or without modification, are permitted provided that the following conditions are met:

- Redistributions of source code must retain the above copyright notice, this list of conditions and the following disclaimer.
- Redistributions in binary form must reproduce the above copyright notice, this list of conditions and the following disclaimer in the documentation and/or other materials provided with the distribution.
- Neither the name of the Xiph.org Foundation nor the names of its contributors may be used to endorse or promote products derived from this software without specific prior written permission.

THIS SOFTWARE IS PROVIDED BY THE COPYRIGHT HOLDERS AND CONTRIBUTORS "AS IS" AND ANY EXPRESS OR IMPLIED WARRANTIES, INCLUDING, BUT NOT LIMITED TO, THE IMPLIED WARRANTIES OF MERCHANTABILITY AND FITNESS FOR A PARTICULAR PURPOSE ARE DISCLAIMED. IN NO EVENT SHALL THE FOUNDATION OR CONTRIBUTORS BE LIABLE FOR ANY DIRECT, INDIRECT, INCIDENTAL, SPECIAL, EXEMPLARY, OR CONSEQUENTIAL DAMAGES (INCLUDING, BUT NOT LIMITED TO, PROCUREMENT OF SUBSTITUTE GOODS OR SERVICES; LOSS OF USE, DATA, OR PROFITS; OR BUSINESS INTERRUPTION) HOWEVER CAUSED AND ON ANY THEORY OF LIABILITY, WHETHER IN CONTRACT, STRICT LIABILITY, OR TORT (INCLUDING NEGLIGENCE OR OTHERWISE) ARISING IN ANY WAY OUT OF THE USE OF THIS SOFTWARE, EVEN IF ADVISED OF THE POSSIBILITY OF SUCH DAMAGE.

Specifications

■ Monitor section

Picture Size

: 6.75 inches (diagonal) wide
: 151.8 mm (W) × 79.7 mm (H)
5-15/16 × 3-1/8 inch

Display System

: Transparent TN LCD panel

Drive System

: TFT active matrix system

Number of Pixels

: 1,152,000 (800H x 480V x RGB)

Effective Pixels

: 99.99 %

Pixel Arrangement

: RGB striped arrangement

Back Lighting

: LED

■ USB interface section

USB Standard

: USB 2.0 High Speed

Compatible Devices

: Mass storage class

File System

: FAT 16/ 32 / NTFS

Maximum Power Supply Current

: DC 5 V  1 A

D/A Converter

: 24 Bit

Audio Decoder

: MP3/ WMA/ WAV/ AAC/ FLAC

Video Decoder

: MPEG1/ MPEG2/ MPEG4/ H.264/ MKV

Frequency Response

- 96 kHz : 20 – 20,000 Hz
- 48 kHz : 20 – 20,000 Hz
- 44.1 kHz : 20 – 20,000 Hz

NOTE

- Although the effective pixels for the liquid crystal panel is given as 99.99% or more, 0.01% of pixels may not light or may light incorrectly.
- Specifications subject to change without notice.

About this Unit

Bluetooth section

Technology

: Bluetooth Ver.4.2

Frequency

: 2.402 – 2.480 GHz

Output Power

: +8 dBm (AVE), Power Class1

Maximum Communication range

: Line of sight approx. 10m (32.8 ft)

Audio Codec

: SBC

Profile (Multi Profile support)

- HFP (V1.6) (Hands Free Profile)
- A2DP (Advanced Audio Distribution Profile)
- AVRCP (V1.5) (Audio/Video Remote Control Profile)
- PBAP (Phonebook Access Profile)
- SPP (Serial Port Profile)

FM tuner section

Frequency Range (step)

: 87.9 MHz – 107.9 MHz (200 kHz)

Usable Sensitivity

: 16.2 dBf

: 1.8 μ V/75 Ω (S/N : 30 dB)

Frequency Response

: 30 Hz – 14 kHz

S/N Ratio (dB)

: 50 dB (MONO)

Stereo Separation

: 35 dB (1 kHz)

AM tuner section

Frequency Range (step)

: 530 – 1700 kHz (10 kHz)

Usable Sensitivity

: 99 μ V (40 dB μ)

Video section

Color System of External Video Input

: NTSC/PAL

External Video Input Level (RCA jacks)

: 1 Vp-p/ 75 Ω

External Video Input Level (RCA jacks, AV-IN)

: 1 Vp-p/ 75 Ω

External Audio Max Input Level (RCA jacks, AV-IN)

: 1.5 V/ 25 k Ω

Video Output Level (RCA jacks)

: 1 Vp-p/ 75 Ω

Audio section

Maximum Power (Front & Rear)

: 45 W \times 4

Full Bandwidth Power (Front & Rear)

Full Bandwidth Power (at less than 1% THD)

: 16 W \times 4

Preout Level (V)

: 2 V/ 10 k Ω

Preout Impedance

: 1.4 k Ω

Speaker Impedance

: 4 – 8 Ω

Equalizer

: 13 Band

Band

Frequency: 62.5/100/160/250/400/630/1k/1.6k/2.5k/
4k/6.3k/10k/16k Hz

Level: -9 – +9

HPF

Frequency: Through / 30/40/50/60/70/80/90/100/
120/150/180/220/250 Hz /

Slope: -6/-12/-18/-24 dB/Oct.

Gain: -8/-7/-6/-5/-4/-3/-2/-1/0 dB

LPF

Frequency: 30/40/50/60/70/80/90/100/120/150/180/
220/250 Hz / through

Slope: -6/-12/-18/-24 dB/Oct.

Gain: -8/-7/-6/-5/-4/-3/-2/-1/0 dB

General

Operating Voltage

: 12V DC car battery

Installation Dimensions (W \times H \times D)

: 182 \times 112 \times 75 mm

7-3/16 \times 4-7/16 \times 2-15/16 inch

Main Unit Installation size (W \times H \times D)

: 178 \times 100 \times 75 mm (w/o sleeve)

7-1/16 \times 3-15/16 \times 2-15/16 inch

Weight

: 1.2 kg (2.7 lbs)

(Including Sleeve and Trim plate)

About this Unit

For USA

FCC WARNING

This equipment may generate or use radio frequency energy. Changes or modifications to this equipment may cause harmful interference unless the modifications are expressly approved in the instruction manual. The user could lose the authority to operate this equipment if an unauthorized change or modification is made.

NOTE

- This equipment has been tested and found to comply with the limits for a Class B digital device, pursuant to Part 15 of the FCC Rules. These limits are designed to provide reasonable protection against harmful interference in a residential installation.
- This equipment may cause harmful interference to radio communications, if it is not installed and used in accordance with the instructions. However, there is no guarantee that interference will not occur in a particular installation. If this equipment does cause harmful interference to radio or television reception, which can be determined by turning the equipment off and on, the user is encouraged to try to correct the interference by one or more of the following measures:
 - Reorient or relocate the receiving antenna.
 - Increase the separation between the equipment and receiver.
 - Connect the equipment into an outlet on a circuit different from that to which the receiver is connected.
 - Consult the dealer or an experienced radio/TV technician for help.

This transmitter must not be co-located or operated in conjunction with any other antenna or transmitter.

For Canada

IC (Industry Canada) Notice

This device complies with Industry Canada licence-exempt RSS standard(s).

Operation is subject to the following two conditions:

- (1) This device may not cause interference, and
- (2) this device must accept any interference, including interference that may cause undesired operation of the device.

CAUTION

This equipment complies with FCC/IC radiation exposure limits set forth for an uncontrolled environment and meets the FCC radio frequency (RF) Exposure Guidelines and RSS-102 of the IC radio frequency (RF) Exposure rules. This equipment has very low levels of RF energy that is deemed to comply without maximum permissive exposure evaluation (MPE). But it is desirable that it should be installed and operated keeping the radiator at least 20 cm or more away from person's body.

Supplier's Declaration of Conformity

Trade Name: JVC
Products: DIGITAL MEDIA RECEIVER
Model Name: KW-M150BT
Responsible Party: JVCKENWOOD USA CORPORATION
2201 East Dominguez Street,
Long Beach, CA 90810, U.S.A.
PHONE: 310 639-9000

THIS DEVICE COMPLIES WITH PART 15 OF THE FCC RULES. OPERATION IS SUBJECT TO THE FOLLOWING TWO CONDITIONS:

- (1) THIS DEVICE MAY NOT CAUSE HARMFUL INTERFERENCE, AND
- (2) THIS DEVICE MUST ACCEPT ANY INTERFERENCE RECEIVED, INCLUDING INTERFERENCE THAT MAY CAUSE UNDESIRE OPERATION.

- Contains Transmitter Module
Contient un module émetteur
- FCC ID: 2AB75-YK5128K01
- Contains Transmitter Module
Contient un module émetteur
- IC: 11888A-YK5128K01

About this Unit

For Argentina

■ Información acerca de la eliminación de equipos eléctricos y electrónicos al final de la vida útil (aplicable a los países que hayan adoptado sistemas independientes de recogida de residuos)



Los productos con el símbolo de un contenedor con ruedas tachado no podrán ser desechados como residuos domésticos.

Los equipos eléctricos y electrónicos al final de la vida útil, deberán ser reciclados en instalaciones que puedan dar el tratamiento adecuado a estos productos y a sus subproductos residuales correspondientes. Póngase en contacto con su administración local para obtener información sobre el punto de recogida más cercano. Un tratamiento correcto del reciclaje y la eliminación de residuos ayuda a conservar los recursos y evita al mismo tiempo efectos perjudiciales en la salud y el medio ambiente.

For Mexico

■ Para cumplimiento de la IFT:

La operación de este equipo esta sujeta a las siguientes dos condiciones:

- (1) es posible que este equipo o dispositivo no cause interferencia perjudicial y
- (2) este equipo o dispositivo debe aceptar cualquier interferencia, incluyendo la que pueda causar su operación no deseada.

JVC



KW-M150BT

MONITOR WITH RECEIVER

Quick Start Guide

ÉCRAN AVEC RÉCEPTEUR

Guide de démarrage rapide

MONITOR CON RECEPTOR

Guía de inicio rápido

JVCKENWOOD Corporation

- For detailed operations and information, refer to the INSTRUCTION MANUAL on the following website:
- Pour plus d'informations et de détails sur les opérations, reportez-vous au MODE D'EMPLOI sur le site Internet suivant :
- Para obtener información y detalles sobre las operaciones, consulte el MANUAL DE INSTRUCCIONES en el siguiente sitio web:

<http://www.jvc.net/cs/car/>



Model name indication position

See "Removing the trim plate" (P.13)

Position d'indication du nom du modèle

Reportez-vous à la section «Retrait de la plaque de garniture» (P.29)

Posición de la indicación del nombre del modelo

Consulte "Retirada del marco" (P.45)

Trim plate
Plaque de garniture
Marco

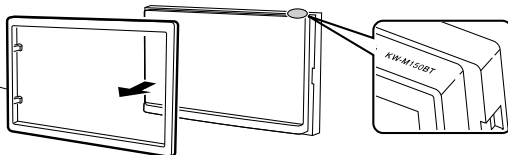

Made for

iPhone | iPod



Contents

Before use	2
How to read this manual	2
Precautions	2
Getting Started	3
Clock settings	3
Basics	4
Functions of the Buttons on the Front Panel	4
Common operations	4
HOME screen	4
Source control screen	4
Tuner	5
Tuner Basic Operation	5
Presetting stations	5
Tuner Setup	5
USB	6
Preparation	6
Playback operations	6
iPod/iPhone	7
Preparation	7
Playback operations	7
External Components	8
Using external audio/video players	8
Rear view camera	8
Bluetooth	9
Register your smartphone to the unit	9
Receive a phone call	9
Make a phone call	9
Controlling Audio	10
Controlling General Audio	10
Playing Bluetooth Audio Device	10
Installation	11
Before Installation	11
Installing the unit	12
About this Unit	16
More information	16
Note for specifications	16
Copyrights	17

How to read this manual

- The panels shown in this guide are examples used to provide clear explanations of the operations. For this reason, they may be different from the actual panels.
- In operation procedures, bracket shape indicates the key or button you should control.
 - < >: indicates the name of panel buttons.
 - []: indicates the name of touch keys

Before use

Precautions

▲WARNING

■ To prevent injury or fire, take the following precautions:

- To prevent a short circuit, never put or leave any metallic objects (such as coins or metal tools) inside the unit.
- Do not watch or fix your eyes on the unit's display when you are driving for any extended period.
- If you experience problems during installation, consult your JVC dealer.

■ Precautions on using this unit

- When you purchase optional accessories, check with your JVC dealer to make sure that they work with your model and in your area.
- The Radio Data System or Radio Broadcast Data System feature won't work where the service is not supported by any broadcasting station.

■ Protecting the monitor

- To protect the monitor from damage, do not operate the monitor using a ballpoint pen or similar tool with the sharp tip.

■ Cleaning the Unit

If the front panel of this unit is stained, wipe it with a dry soft cloth such as a silicon cloth. If the front panel is stained badly, wipe the stain off with a cloth moistened with neutral cleaner, then wipe it again with a clean soft dry cloth.

▲CAUTION

- Applying spray cleaner directly to the unit may affect its mechanical parts. Wiping the front panel with a hard cloth or using a volatile liquid such as thinner or alcohol may scratch the surface or erase screened print.

■ How to reset your unit

If the unit or the connected unit fails to operate properly, reset the unit.

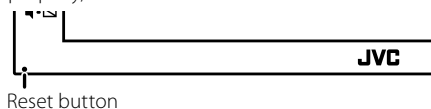

Getting Started

1 Turn the ignition key of your car to ACC.

The unit is turned on.

2 Press the <Home> button.

3 Touch [Setting].



4 Touch the corresponding key and set the value.



[System]

[Beep Tone]

Activates or deactivates the key-touch tone.
"ON" (Default), "OFF"

[Language]

Select the language used for the control screen and setting items. Default is "English".

[Time/Date]

Adjust the clock time. (P.3)

[Clock Mode]

Select the time display format.
[12hr] (Default) / [24hr]

[Steering Remote]

Sets the desired function in the steering remote controller.

[Parking Guidelines]

You can display parking guidelines to enable easier parking when you shift the gear to the reverse (R) position. Default is "ON".

[Guidelines SETUP]

If you select [ON] for [Parking Guidelines], you can adjust the parking guidelines.

[System Reset]

Touch [System Reset] and then touch [YES] to set all the settings to the initial default settings.

[Bluetooth]

Displays the Bluetooth Settings screen.

[Screen]

[Dimmer]

Select the dimmer mode.
"High" (Default) / "Mid" / "Low"

[Demo]

Select the demonstration mode. Default is "ON".

5 Touch [↵].

Clock settings

■ Synchronizing the clock time with FM RDS

Activate [RDS Clock Sync].
See **Tuner Setup (P.5)**.

■ Adjusting the clock manually

📎 NOTE

- Deactivate [RDS Clock Sync] before adjusting the clock.

1 Press the <Home> button.

2 Touch [Setting].

3 Touch [System].

4 Touch [Time/Date].

Clock screen appears.

5 Touch [▲] or [▼] to set the clock time.

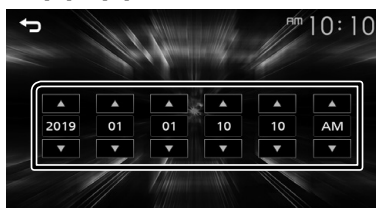

6 Touch [↵].

Basics

Functions of the Buttons on the Front Panel

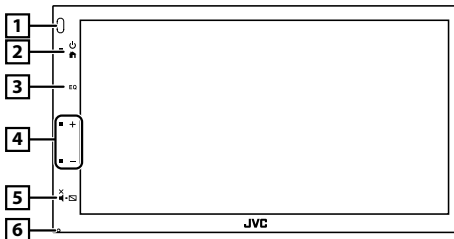

- 1 Remote Sensor**
 - Receives the remote control signal.
- 2 (HOME)**
 - Displays the HOME screen. **(P.4)**
 - Pressing for 1 second turns the power off.
 - When the power off, turns the power on.
- 3 EQ**
 - Displays the Audio screen.* **(P.10)**
 - * The Audio screen is not displayed during SETUP screen or on the list screen etc.
- 4 +, - (Volume)**
 - Adjusts volume. The volume will go up until 20 when you keep pressing [+].
- 5 (MUTE, Display off)**
 - Mutes/restores the sound.
 - Pressing for 1 second turns the screen off.
 - When the screen is off, touch the display to turn on the screen.
- 6 Reset**
 - If the unit or the connected unit fails to operate properly, the unit returns to factory settings when this button is pressed.

Common operations

Turning on the power

- 1 Press the button.



Turning off the power

- 1 Press and hold the button.

HOME screen

- 1 Press the button.

HOME screen appears.



- 1 Clock display
- 2 Switches to the Tuner broadcast. **(P.5)**
- 3 **[USB]** Plays files on a USB device. **(P.6)**
[iPod] Plays an iPod/iPhone. **(P.7)**
 - When iPod/iPhone is connected.**[Mirroring]** Displays the Mirroring screen.
 - When android device with "Mirroring OB for JVC" application installed is connected.
- 4 Switches to an external component connected to the AV-IN input terminal. **(P.8)**
- 5 Displays the Hands Free screen. **(P.9)**
- 6 Plays a Bluetooth audio player. **(P.10)**
- 7 Displays the SETUP screen. **(P.3)**

Source control screen



- 1 **[]**: Returns to previous screen.
[]: Displays the Audio screen. **(P.10)**

Tuner

Tuner Basic Operation

- 1 Press the button.
- 2 Touch [Tuner].

Source control screen



- 1 Displays the information of the current station:
PS name, Frequency, PTY Genre, Indicator Items
- 2 **[FM]**: Switches the FM band.
“FM1”, “FM2”, “FM3”
[AM]: Switches the AM band.
“AM1”, “AM2”
[]: Tunes in a station with good reception automatically.
[]: Displays the Tuner Setup screen. **(P.5)**
- 3 Recalls the memorized station.
When touched for 2 seconds, stores the current receiving station in memory.

Presetting stations

Auto memory

You can preset 6 stations for the current band (FM1/FM2/FM3/AM1/AM2).

- 1 Touch **[FM]** or **[AM]** to select the band.
- 2 Touch [].
- 3 Touch **[Auto Store]**.
The local stations with the strongest signals are found and stored automatically.

Manual memory

You can store the current receiving station in memory.

- 1 Tune in to a station you want to preset.
- 2 Touch and hold **[#]** (#:1-6) in which you want to store the station.

Recalling the preset station

- 1 Touch **[#]** (:1-6).

Tuner Setup

- 1 Touch [].
- 2 Set each item as follows.



[Auto Store]

Automatically searches and stores the 6 stations with the strongest signals for the selected band.

“Auto Store” appears.

[Area]

“N.America” (Default): For North/Central/South America, AM/FM intervals: 10 kHz/200 kHz.

“S.America”: For some South American countries, AM/FM intervals: 10 kHz/50 kHz.

“Europe”: For Europe, AM/FM intervals: 9 kHz/50 kHz.

[Local Seek]

Tunes in only to the stations with sufficient signal strength. (**LOC** indicator lights up.)

“ON”, “OFF” (Default)

[RDS Clock Sync] *1 *3

Synchronizing the Radio Data System station time data and this unit's clock.

“ON” (Default), “OFF”

[RDS] *2 *3

Displays the RDS Settings screen.

*1 To use the function, it is necessary to set [Area] to [N.America]/[S.America].

*2 To use the function, it is necessary to set [Area] to [Europe].

*3 FM only

- 3 Touch [].

USB

Preparation

■ Connecting a USB device

- 1 Remove the cap of the USB terminal.
- 2 Connect the USB device with the USB cable.

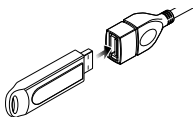

The unit reads the device and playback starts.

■ To disconnect the USB device:

- 1 Press the <⏮> button.
- 2 Touch a source other than [USB].
- 3 Detach the USB device.

■ Usable USB device

This unit can play MPEG1/ MPEG2/ MPEG4/ H.264/ MKV/ MP3/WMA/ AAC/ WAV/ FLAC/ OGG files stored in a USB mass storage class device.

Playback operations

■ Control the music you are listening to on the source control screen.



- 1 The jacket of the currently playing file is displayed.
- 2 Displays the information of the current file.
- 3 Playing time/File number
Play time bar : For confirmation of current playing position.
- 4 [⏮]: Selects Random playback mode.
[⏪]: Selects Repeat playback mode.
[▶], [⏸]: Plays or pauses.
[◀◀], [▶▶]: Searches the previous/next content.
Touch and hold to fast forward or fast backward.
[Q]: Searches file. (P.6)

■ For Video playback

- 1 When the operation buttons are not displayed on the screen, touch the display.

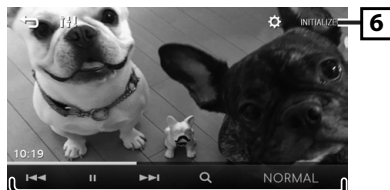

- 6 [⚙️]: You can adjust image quality in video screen.
[INITIALIZE]: To clear the adjustment.
- 7 [▶], [⏸]: Plays or pauses.
[◀◀], [▶▶]: Searches the previous/next content.
Touch and hold to fast forward or fast backward.
[Q]: Searches file. (P.6)
[NORMAL]/[16:9]/[4:3]: Select a screen mode.

■ Selecting a track in a list (Searches file)

- 1 Touch [Q].
- 2 Select whether you search by audio files [🎵], video files [📺].
- 3 Touch [⏮] to moves to the upper hierarchy.
- 4 Touch the desired folder.
When you touch a folder its contents are displayed.
• Touch [⏮] to moves to the upper hierarchy.
- 5 Touch desired item from the content list.
Playback starts.

📎 NOTE

- The source control screen appears when you touch [⏮] at the top hierarchy.

iPod/iPhone

Preparation

■ Connecting iPod/iPhone

- For Lightning connector models: Use USB Audio cable for iPod/iPhone—KS-U62 (optional accessory).
- For details about connecting iPod/iPhone, see page 15 .

1 Remove the cap of the USB terminal.

2 Connect the iPod/iPhone.

The unit reads the device and playback starts.

■ To disconnect the iPod/iPhone

1 Press the <Home> button.

2 Touch a source other than [iPod].

3 Detach the iPod/iPhone.

■ Connectable iPod/iPhone

The following models can be connected to this unit.

Made for

- | | | |
|-----------------|------------------|-----------------|
| • iPhone XS Max | • iPhone 8 | • iPhone 6s |
| • iPhone XS | • iPhone 7 Plus | • iPhone 6 Plus |
| • iPhone XR | • iPhone 7 | • iPhone 6 |
| • iPhone X | • iPhone SE | • iPhone 5s |
| • iPhone 8 Plus | • iPhone 6s Plus | |

📎 NOTE

- If you start playback after connecting the iPod, the music that has been played by the iPod is played first.
- Cap the USB terminal whenever not using.

Playback operations

■ Control the music you are listening to on the source control screen.

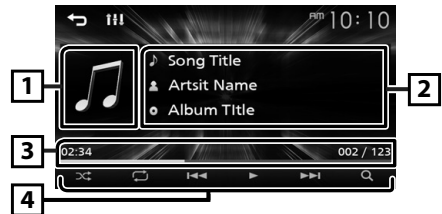

1 Artwork (Shown if the track contains artwork)

2 Displays the information of the current file.

3 Playing time/File number
Play time bar : For confirmation of current playing position.

4 [⏮] : Selects Random playback mode.

[⏪] : Selects Repeat playback mode.

[▶], [⏸] : Plays or pauses.

[⏮], [⏭] : Searches the previous/next content.

Touch and hold to fast forward or fast backward.

[🔍] : Searches content. (P.7)

■ Selecting a content in a list

1 Touch [Q].

2 Touch desired item.

When you touch a category its contents are displayed.

3 Touch desired item from the content list.

Playback starts.

- Touch [↶] to moves to the upper hierarchy.

📎 NOTE

- The source control screen appears when you touch [↶] at the top hierarchy.

External Components

Using external audio/video players

Starting playback

- 1 Connect an external component to the AV-IN input terminal. (P.14)
- 2 Press the button.
- 3 Touch [AV-IN].
- 4 Turn on the connected component and start playing the source.

For Video playback

- 1 When the operation buttons are not displayed on the screen, touch the display.

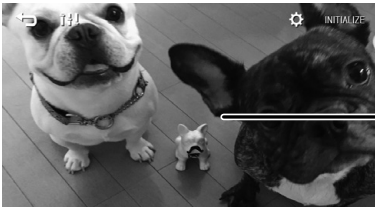

Rear view camera

To use a rear view camera, the REVERSE lead connection is required. For connecting a rear view camera. (P.14)

Displaying the picture from the rear view camera

The rear view screen is displayed when you shift the gear to the reverse (R) position.



- To erase the caution message, touch the screen.

Bluetooth

Register your smartphone to the unit

You can use your Bluetooth smartphone when paired to this unit.

- 1 Turn on the Bluetooth function on your smartphone/cell-phone.
- 2 Search the unit ("KW-M150BT") from your smartphone/cell-phone.

If a PIN code is required, enter the PIN code ("0000").

-  appears when the Bluetooth smartphone is connected.

Disconnecting the device

- Turn off the Bluetooth function from your smartphone/cell-phone.
- Turn off the ignition switch.

Receive a phone call

- 1 Touch .

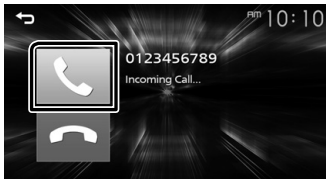

- : Reject an incoming call.

Operations during a call



 Ending a call

 You can send tones by touching desired keys on the screen.

- Touch  to close the window.

 Switches the speaking voice output between smartphone/cell-phone and speaker.

- Adjust the receiver volume
Press the <+> or <-> button.

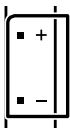



Make a phone call





- 1 Press the  button.
- 2 Touch [Phone].
- 3 See the table below for each operation method.





Call by entering a phone number

- 1) Enter a phone number with number keys.
 - 2) Touch .
- Make a call
- Touch  to delete the last entry.

Call using call records

- 1) Touch .
- 2) Touch  (Incoming Calls),  (Outgoing Calls), .
- 3) Select the phone number from the list.
Make a call

Call using the phonebook

- 1) Touch .
 - 2) Select the name from the list.
Make a call
- : Updates the phonebook. Touch this button after you have made a change to the phonebook of your smartphone/cell-phone.

Bluetooth

Playing Bluetooth Audio Device

- 1 Press the <H> button.
- 2 Touch [BT Audio].

Source control screen

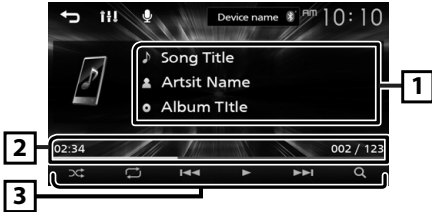

- 1 Displays the information of the current file.
- 2 Playing time/File number
Play time bar : For confirmation of current playing position.

- 3 [<D>] : Selects Random playback mode.
 [<R>] : Selects Repeat playback mode.
 [>P>], [>||>] : Plays or pauses.
 [<P><<<], [>>>>] : Searches the previous/next content.
 Touch and hold to fast forward or fast backward.
 [<Q>] : Searches file. **(P.10)**

NOTE

- Operations and display indications may differ according to their availability on the connected device.

Selecting a content in a list

- 1 Touch [Q].
- 2 Touch desired item.
 When you touch a category its contents are displayed.
- 3 Touch desired item from the content list.
 Playback starts.
 - Touch [] to moves to the upper hierarchy.

NOTE

- The source control screen appears when you touch [] at the top hierarchy.

Controlling Audio

You can adjust various settings such as audio balance or subwoofer level.

- 1 Press the <EQ> button.
- 2 See the below for each operation method.



Controlling General Audio

- 1 Press the <EQ> button.
- 2 Touch [Fader / Balance].
- 3 Set each item as follows.

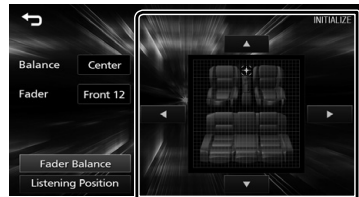

[Fader Balance]

Balance Adjust the left and right volume balance.

[>P>] [<P>]
 15 (right) to 15 (left)

Fader Adjust the front and rear volume balance.

[>A>] [>V>]
 15 (front) to 15 (rear)

[INITIALIZE] To clear the adjustment.

Installation

Before Installation

Before installation of this unit, please note the following precautions.

▲WARNINGS

- If you connect the ignition wire (red) and the battery wire (yellow) to the car chassis (ground), you may cause a short circuit, that in turn may start a fire. Always connect those wires to the power source running through the fuse box.
- Do not cut out the fuse from the ignition wire (red) and the battery wire (yellow). The power supply must be connected to the wires via the fuse.

▲CAUTION

- Install this unit in the console of your vehicle. Do not touch the metal part of this unit during and shortly after the use of the unit. Metal part such as the heat sink and enclosure become hot.

🔧 NOTE







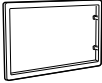

- Mounting and wiring this product requires skills and experience. For best safety, leave the mounting and wiring work to professionals.
- Make sure to ground the unit to a negative 12V DC power supply.
- Do not install the unit in a spot exposed to direct sunlight or excessive heat or humidity. Also avoid places with too much dust or the possibility of water splashing.
- Do not use your own screws. Use only the screws provided. If you use the wrong screws, you could damage the unit.
- If your car's ignition does not have an ACC position, connect the ignition wires to a power source that can be turned on and off with the ignition key. If you connect the ignition wire to a power source with a constant voltage supply, such as with battery wires, the battery may be drained.
- If the console has a lid, make sure to install the unit so that the front panel will not hit the lid when closing and opening.
- If the fuse blows, first make sure the wires aren't touching to cause a short circuit, then replace the old fuse with one with the same rating.
- Insulate unconnected wires with vinyl tape or other similar material. To prevent a short circuit, do not remove the caps on the ends of the unconnected wires or the terminals.
- Secure the wires with cable clamps and wrap vinyl tape around the wires that comes into contact with metal parts to protect the wires and to prevent short circuit.

- Connect the speaker wires correctly to the terminals to which they correspond. The unit may be damaged or fail to work if you share the ⊖ wires or ground them to any metal part in the car.
- When only two speakers are being connected to the system, connect the connectors either to both the front output terminals or to both the rear output terminals (do not mix front and rear). For example, if you connect the ⊕ connector of the left speaker to a front output terminal, do not connect the ⊖ connector to a rear output terminal.
- After the unit is installed, check whether the brake lamps, blinkers, wipers, etc. on the car are working properly.
- Mount the unit so that the mounting angle is 30° or less.
- Do not press hard on the panel surface when installing the unit to the vehicle. Otherwise scars, damage, or failure may result.
- Reception may drop if there are metal objects near the Bluetooth antenna.



Installation

Supplied accessories for installation

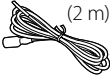
①		②		x1	x2
③		④ (3 m)		x1	x1
⑤		⑥		x1	x1
⑦		⑧		x6	x6
⑨				x1	

Installation procedure

- 1) To prevent a short circuit, remove the key from the ignition and disconnect the \ominus terminal of the battery.
- 2) Make the proper input and output wire connections for each unit.
- 3) Connect the wire on the wiring harness.
- 4) Take Connector B on the wiring harness and connect it to the speaker connector in your vehicle.
- 5) Take Connector A on the wiring harness and connect it to the external power connector on your vehicle.
- 6) Connect the wiring harness connector to the unit.
- 7) Install the unit in your car.
- 8) Reconnect the \ominus terminal of the battery.
- 9) Press the reset button.

Installing the unit

Non-Japanese cars

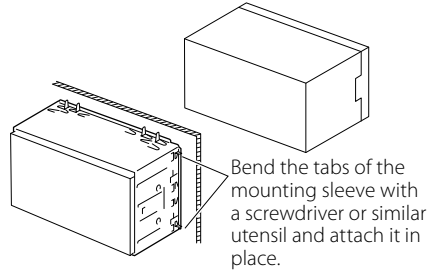

NOTE

- Make sure that the unit is installed securely in place. If the unit is unstable, it may malfunction (eg, the sound may skip).

Japanese cars (North America, South America sales area only)

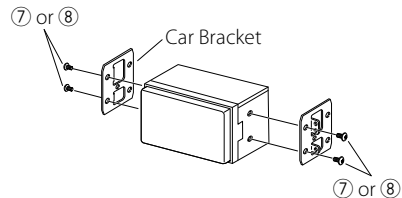

Trim plate

- 1) Attach accessory ① to the unit.

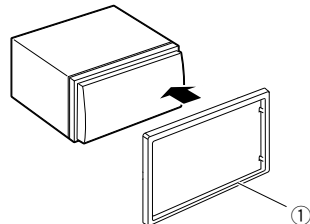

Installation

Microphone unit

- 1) Check the installation position of the microphone (accessory ④).
- 2) Clean the installation surface.
- 3) Remove the separator of the microphone (accessory ④), and stick the microphone to the place shown below.
- 4) Wire the microphone cable up to the unit with it secured at several positions using tape or other desired method.
- 5) Adjust the direction of the microphone (accessory ④) to the driver.

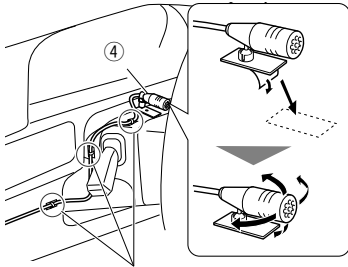

Fix a cable with a commercial item of tape.

NOTE

- Swap the clips if necessary.

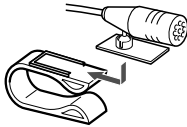

Removing the trim plate

- 1) Use the extraction key (accessory ③) to lever out the four tabs (two on the left part, two on the right part).

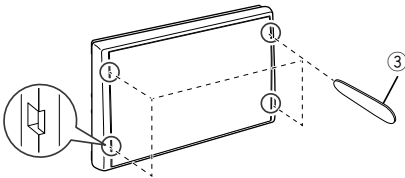

- 2) Pull the trim plate forward.

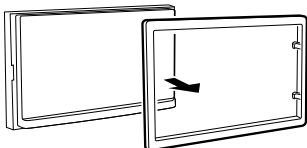

Removing the unit

- 1) Remove the trim plate by referring to step 1 in "Removing the trim plate".
- 2) Insert the extraction key (accessory ②) deeply into the slot as shown. (The protrusion at the tip of the extraction key must face toward the unit.)

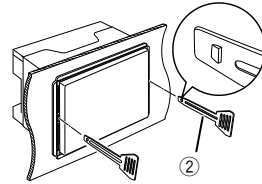

- 3) With the inserted extraction key secured, insert the other extraction key into the slot.

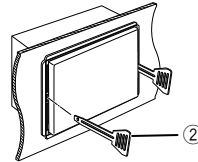

- 4) Pull out the unit halfway.

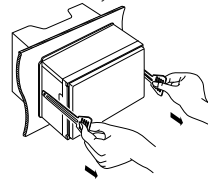

NOTE

- Be careful to avoid injury from the catch pins on the extraction key.
- 5) Pull the unit all the way out with your hands, being careful not to drop it.

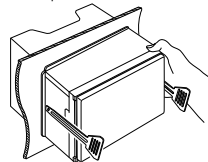

Installation

Connecting wires to terminals

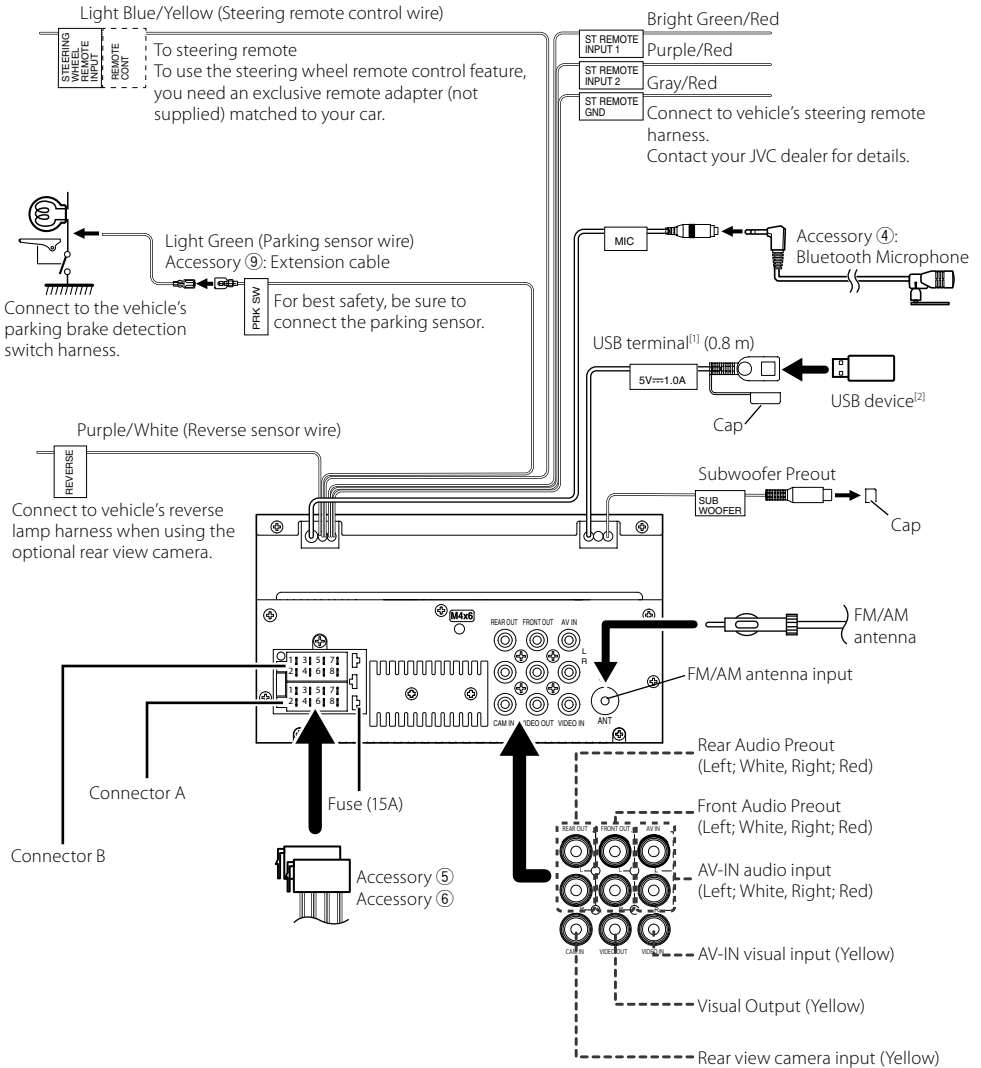

^[1] USB maximum power supply current :
DC 5 V = 1.0 A

^[2] Sold separately

^[3] Max. 150mA, 12V

Installation

■ Connecting an iPod/iPhone/Android

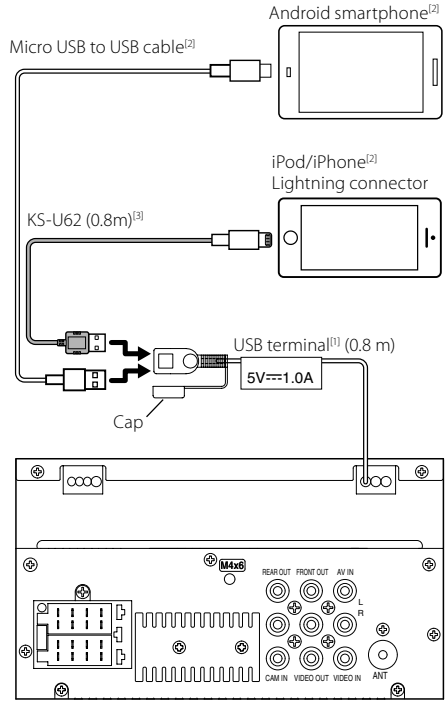
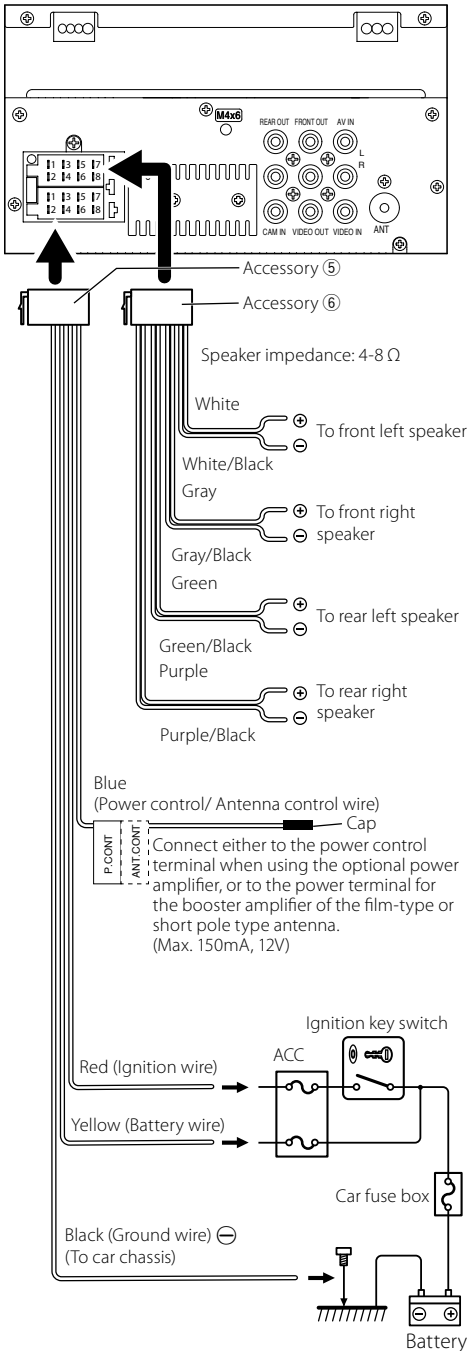

[1] USB maximum power supply current : DC 5 V --- 1.0 A
 [2] Sold separately
 [3] Optional accessory

About this Unit

More information

Usable USB device

This unit can play MPEG1/ MPEG2/ MPEG4/ H.264/ MKV/ MP3/WMA/ AAC/ WAV/ FLAC/ OGG files stored in a USB mass storage class device.

- File system: FAT16/ FAT32

NOTE

- When the USB device is connected to this unit, it can be charged through the USB cable.
- Install the USB device in the place where it will not affect safe driving.
- You cannot connect a USB device via a USB hub and Multi Card Reader.
- Take backups of the audio files used with this unit. The files may be erased depending on the operating conditions of the USB device.
We shall have no compensation for any damage arising from any erased data.
- No USB device comes with this unit. You need to purchase a commercially available USB device.
- Cap the USB terminal whenever not using.

Playable Audio files

Audio format	Extension
MP3	.mp3
WMA	.wma
AAC-LC	.m4a, .aac
Linear PCM (WAVE)	.wav
FLAC	.flac
Vorbis	.ogg

- This unit can show ID3 Tag Version 1.0/1.1/2.2/2.3/2.4 (for MP3).

NOTE

- WMA and AAC of which is covered with DRM cannot be played.
- Although the audio files are complied with the standards listed above, the play may be impossible depending on the types or conditions of media or device.

Acceptable Video files

Video format	Extension
MPEG-1	.mpg, .mpeg
MPEG-2	.mpg, .mpeg
MPEG-4	.mp4, .avi
H.264/MPEG-4 AVC	.mp4, mkv, avi, .flv, .f4v, .ts
MKV	.mkv

Note for specifications

Bluetooth section

Frequency
: 2.402 – 2.480 GHz

Output Power
: +8 dBm (AVE), Power Class1

General

Speaker Impedance

: 4 – 8 Ω

Operating Voltage

: 12 V DC car battery

About this Unit

Copyrights

- The Bluetooth word mark and logos are registered trademarks owned by the Bluetooth SIG, Inc. and any use of such marks by JVC KENWOOD Corporation is under license. Other trademarks and trade names are those of their respective owners.
- Use of the Made for Apple badge means that an accessory has been designed to connect specifically to the Apple product(s) identified in the badge, and has been certified by the developer to meet Apple performance standards. Apple is not responsible for the operation of this device or its compliance with safety and regulatory standards. Please note that the use of this accessory with an Apple product may affect wireless performance.
- Apple, iPhone, iPod, iPod touch, and Lightning are trademarks of Apple Inc., registered in the U.S. and other countries.
- Microsoft and Windows Media are either registered trademarks or trademarks of Microsoft Corporation in the United States and/or other countries.
- THIS PRODUCT IS LICENSED UNDER THE MPEG-4 VISUAL PATENT PORTFOLIO LICENSE FOR THE PERSONAL AND NON-COMMERCIAL USE OF A CONSUMER FOR (i) ENCODING VIDEO IN COMPLIANCE WITH THE MPEG-4 VISUAL STANDARD ("MPEG-4 VIDEO") AND/OR (ii) DECODING MPEG-4 VIDEO THAT WAS ENCODED BY A CONSUMER ENGAGED IN A PERSONAL AND NON-COMMERCIAL ACTIVITY AND/OR WAS OBTAINED FROM A VIDEO PROVIDER LICENSED BY MPEG LA TO PROVIDE MPEG-4 VIDEO. NO LICENSE IS GRANTED OR SHALL BE IMPLIED FOR ANY OTHER USE. ADDITIONAL INFORMATION INCLUDING THAT RELATING TO PROMOTIONAL, INTERNAL AND COMMERCIAL USES AND LICENSING MAY BE OBTAINED FROM MPEG LA, LLC. SEE [HTTP://WWW.MPEGLA.COM](http://www.mpegla.com).
- THIS PRODUCT IS LICENSED UNDER THE AVC PATENT PORTFOLIO LICENSE FOR THE PERSONAL USE OF A CONSUMER OR OTHER USES IN WHICH IT DOES NOT RECEIVE REMUNERATION TO (i) ENCODE VIDEO IN COMPLIANCE WITH THE AVC STANDARD ("AVC VIDEO") AND/OR (ii) DECODE AVC VIDEO THAT WAS ENCODED BY A CONSUMER ENGAGED IN A PERSONAL ACTIVITY AND/OR WAS OBTAINED FROM A VIDEO PROVIDER LICENSED TO PROVIDE AVC VIDEO. NO LICENSE IS GRANTED OR SHALL BE IMPLIED FOR ANY OTHER USE. ADDITIONAL INFORMATION MAY BE OBTAINED FROM MPEG LA, L.L.C. SEE [HTTP://WWW.MPEGLA.COM](http://www.mpegla.com)
- libFLAC
Copyright (C) 2000-2009 Josh Coalson
Copyright (C) 2011-2013 Xiph.Org Foundation
 - Redistribution and use in source and binary forms, with or without modification, are permitted provided that the following conditions are met:
 - Redistributions of source code must retain the above copyright notice, this list of conditions and the following disclaimer.
- Redistributions in binary form must reproduce the above copyright notice, this list of conditions and the following disclaimer in the documentation and/or other materials provided with the distribution.
Neither the name of the Xiph.org Foundation nor the names of its contributors may be used to endorse or promote products derived from this software without specific prior written permission.
THIS SOFTWARE IS PROVIDED BY THE COPYRIGHT HOLDERS AND CONTRIBUTORS "AS IS" AND ANY EXPRESS OR IMPLIED WARRANTIES, INCLUDING, BUT NOT LIMITED TO, THE IMPLIED WARRANTIES OF MERCHANTABILITY AND FITNESS FOR A PARTICULAR PURPOSE ARE DISCLAIMED. IN NO EVENT SHALL THE FOUNDATION OR CONTRIBUTORS BE LIABLE FOR ANY DIRECT, INDIRECT, INCIDENTAL, SPECIAL, EXEMPLARY, OR CONSEQUENTIAL DAMAGES (INCLUDING, BUT NOT LIMITED TO, PROCUREMENT OF SUBSTITUTE GOODS OR SERVICES; LOSS OF USE, DATA, OR PROFITS; OR BUSINESS INTERRUPTION) HOWEVER CAUSED AND ON ANY THEORY OF LIABILITY, WHETHER IN CONTRACT, STRICT LIABILITY, OR TORT (INCLUDING NEGLIGENCE OR OTHERWISE) ARISING IN ANY WAY OUT OF THE USE OF THIS SOFTWARE, EVEN IF ADVISED OF THE POSSIBILITY OF SUCH DAMAGE.
- libogg
Copyright (c) 2002, Xiph.org Foundation
Redistribution and use in source and binary forms, with or without modification, are permitted provided that the following conditions are met:
 - Redistributions of source code must retain the above copyright notice, this list of conditions and the following disclaimer.
 - Redistributions in binary form must reproduce the above copyright notice, this list of conditions and the following disclaimer in the documentation and/or other materials provided with the distribution.
 - Neither the name of the Xiph.org Foundation nor the names of its contributors may be used to endorse or promote products derived from this software without specific prior written permission.THIS SOFTWARE IS PROVIDED BY THE COPYRIGHT HOLDERS AND CONTRIBUTORS "AS IS" AND ANY EXPRESS OR IMPLIED WARRANTIES, INCLUDING, BUT NOT LIMITED TO, THE IMPLIED WARRANTIES OF MERCHANTABILITY AND FITNESS FOR A PARTICULAR PURPOSE ARE DISCLAIMED. IN NO EVENT SHALL THE FOUNDATION OR CONTRIBUTORS BE LIABLE FOR ANY DIRECT, INDIRECT, INCIDENTAL, SPECIAL, EXEMPLARY, OR CONSEQUENTIAL DAMAGES (INCLUDING, BUT NOT LIMITED TO, PROCUREMENT OF SUBSTITUTE GOODS OR SERVICES; LOSS OF USE, DATA, OR PROFITS; OR BUSINESS INTERRUPTION) HOWEVER CAUSED AND ON ANY THEORY OF LIABILITY, WHETHER IN CONTRACT, STRICT LIABILITY, OR TORT (INCLUDING NEGLIGENCE OR OTHERWISE) ARISING IN ANY WAY OUT OF THE USE OF THIS SOFTWARE, EVEN IF ADVISED OF THE POSSIBILITY OF SUCH DAMAGE.

JVC

TO OUR VALUED CUSTOMER

THANK YOU FOR PURCHASING THIS JVC PRODUCT.
WE WANT TO HELP YOU ACHIEVE A PERFECT EXPERIENCE.

**NEED HELP ON HOW TO HOOK UP?
NEED ASSISTANCE ON HOW TO OPERATE?
NEED TO LOCATE A JVC SERVICE CENTER?
LIKE TO PURCHASE ACCESSORIES?**

JVC IS HERE TO HELP!
TOLL FREE: 1 (800)252-5722
<http://www.us.jvckenwood.com>

Remember to retain your Bill of Sale for Warranty Service.

Do not attempt to service the product yourself

Caution

To prevent electrical shock, do not open the cabinet.
There are no user serviceable parts inside.
Please refer to qualified service personnel for repairs.

PRODUCT REGISTRATION

We suggest that you register your product since it will enable us to contact you directly if it is ever necessary to correct a safety related condition in your product. You can register at <http://www.us.jvckenwood.com>. Please note that failure to register does not diminish any of your rights during the warranty period.

JVC

LIMITED WARRANTY

ONLY FOR PRODUCT PURCHASED IN U.S.A.

JVCKENWOOD USA Corporation warrants this product and all parts thereof, except as set forth below **ONLY TO THE ORIGINAL RETAIL PURCHASER** to be **FREE FROM DEFECTIVE MATERIALS AND WORKMANSHIP** from the date of original purchase for the period shown below. ("The Warranty Period")

PARTS 2 YRS / LABOR 2 YRS : Car audio ARSENAL series

PARTS 1 YR / LABOR 1 YR : All other car audio products

THIS LIMITED WARRANTY IS VALID ONLY IN THE FIFTY (50) UNITED STATES, THE DISTRICT OF COLUMBIA AND IN THE COMMONWEALTH OF PUERTO RICO.

WHAT WE WILL DO:

If this product is found to be defective within the warranty period, JVC will repair or replace defective parts with new or rebuilt equivalents at no charge to the original owner. Such repair and replacement services shall be rendered by JVC during normal business hours at JVC authorized service centers. Parts used for replacement are warranted only for the remainder of the Warranty Period. All products may be brought to a JVC authorized service center on a carry-in basis.

WHAT YOU MUST DO FOR WARRANTY SERVICE:

Please do not return your product to the retailer. Instead, return your product to the JVC authorized service center nearest you. If shipping the product to the service center, please be sure to package it carefully, preferably in the original packaging, and include a brief description of the problem(s) and a copy of the proof of purchase to verify purchase date. Please call 1-800-252-5722 to locate the nearest JVC authorized service center. Service locations can also be obtained from our website <http://www.us.jvckenwood.com>.

If you have any questions concerning your JVC Product, please contact our Customer Care Center at 800-252-5722

WHAT IS NOT COVERED:

This limited warranty provided by JVC does not cover:

1. Products which have been subject to abuse, accident, alteration, modification, tampering, negligence, misuse, faulty installation, lack of reasonable care, or if repaired or serviced by anyone other than a service facility authorized by JVC to render such service, or if affixed to any attachment not provided with the products, or if the model or serial number has been altered, tampered with, defaced or removed;
2. Initial installation, installation and removal from cabinets or mounting systems.
3. Operational adjustments covered in the Owner's Manual, normal maintenance, video and audio head cleaning;
4. Damage that occurs in shipment, due to act of God, and cosmetic damage;
5. Signal reception problems and failures due to line power surge;
6. User Removal Memory Devices/Video Pick-up Tubes/CCD Image Sensors are covered for 90 days from the date of purchase;
7. Accessories;
8. Batteries (except that Rechargeable Batteries are covered for 90 days from the date of purchase);
9. Products used for commercial purposes, including, but not limited to rental.
10. Loss of data resultant from malfunction of hard drive or other data storage device;

There are no express warranties except as listed above.

THE DURATION OF ANY IMPLIED WARRANTIES, INCLUDING THE IMPLIED WARRANTY OF MERCHANTABILITY, IS LIMITED TO THE DURATION OF THE EXPRESS WARRANTY HEREIN. JVC SHALL NOT BE LIABLE FOR ANY LOSS OF USE OF THE PRODUCT, INCONVENIENCE, OR ANY OTHER DAMAGES, WHETHER DIRECT, INCIDENTAL OR CONSEQUENTIAL (INCLUDING, WITHOUT LIMITATION, DAMAGE TO TAPES, RECORDS OR DISCS) RESULTING FROM THE USE OF THIS PRODUCT, OR ARISING OUT OF ANY BREACH OF THIS WARRANTY. ALL EXPRESS AND IMPLIED WARRANTIES, INCLUDING THE WARRANTIES OF MERCHANTABILITY AND FITNESS FOR PARTICULAR PURPOSE, ARE LIMITED TO THE WARRANTY PERIOD SET FORTH ABOVE.

Some states do not allow the exclusion of incidental or consequential damages or limitations on how long an implied warranty lasts, so these limitations or exclusions may not apply to you. This warranty gives you specific legal rights and you may also have other rights which vary from state to state.

JVCKENWOOD USA Corporation

P.O. Box 22745, 2201 East Dominguez Street, Long Beach, CA 90801-5745
<http://www.us.jvckenwood.com>

REFURBISHED PRODUCTS CARRY A SEPARATE WARRANTY, THIS WARRANTY DOES NOT APPLY. FOR DETAIL OF REFURBISHED PRODUCT WARRANTY, PLEASE REFER TO THE REFURBISHED PRODUCT WARRANTY INFORMATION PACKAGED WITH EACH REFURBISHED PRODUCT.

For customer use:

Enter below the Model No. and Serial No. which is located either on the rear, bottom or side of the cabinet. Retain this information for future reference.

Model No.: _____

Serial No.: _____

Purchase date: _____

Name of dealer: _____

JVC**WARRANTY**

Warranty applies only to PRODUCT distributed in Canada by JVCKENWOOD CANADA INC.

JVCKENWOOD CANADA INC. (hereafter called "JVC") gives the following express warranty for each new JVC product distributed in Canada by JVC and sold by an authorized JVC dealer. JVC warrants that this JVC product is free, under normal use and maintenance, from any defects in material and workmanship subject to the following terms and conditions:

1. To Obtain Warranty Service:

- JVC product requiring service must be presented together with proof of purchase.
- The JVC product must be brought in for service to an authorized JVC Service Centre.

2. Limitation:

This Warranty shall not apply to:

- Repair or replacement of any cabinets, batteries, plates, connection cords, antennas, dust covers, knobs, speaker grills, speaker cones, projection screens, projection screen savers, and all accessories.
- Any defects caused or repairs required as a result of misuse, abusive operation, negligence, improper use and/or insufficient care.
- Any defect caused or repairs required as a result of not following the instructions in the operation manual.
- Any JVC product tampered with, adjusted or repaired by any party other than JVC or authorized JVC Service Centre personnel.
- Any JVC products on which the serial number has been defaced, modified or removed.
- Maintenance, cleaning or periodic check-up
- Conversion to foreign or domestic voltage or frequency.
- Any JVC product without the Canadian Electrical Safety Regulations ID.
- Any JVC products used for commercial or institutional, rental, or display purposes.
Parts 1 year (except video head - 90 days)
Labour ... 90 days
- Any JVC product which has been resold and no longer owned by the original purchaser.
- Product purchased from "outside Canada", "bankruptcy" or "liquidator".
- Any defects caused by fire, flood, lightning, power surge, or other events beyond the control of JVC.

(m) FOR AUTO PRODUCTS

Warranty does not cover elimination of car static or electrical interferences, cleaning of head, adjustments, or labour cost for the removal or reinstallation of the unit for repair.

3. Standards:

If any defects should be found in a JVC product within the applicable terms, necessary repairs shall be made at no cost to the purchaser for parts or labour when JVC acknowledges that such defects are due to faulty material or workmanship.

4. Exclusion of All Other Express Warranties:

This warranty constitutes the entire express warranty given by JVC for JVC products and no dealer or service centre personnel or his, its or their agent or employee is, or are authorized to extend or enlarge this warranty on behalf of JVC.

5. Disclaimer of Consequential Damage:

To the extent the law permits JVC disclaims any responsibility for loss of time or use of its product, transportation costs, or any other indirect, incidental or consequential damage or inconvenience.

WARRANTY TERM (VALID FROM THE DATE OF PURCHASE)

Product	Parts (Years)	Labour (Years)
Projection TV In-Home Service Colour TV In-Home (25" and above) D-ILA Rear Projection In-Home Service LCD TV In-Home Service (25" and above)	1	1
* In-Home service to be provided where available. Where it is not available, the purchaser must assume the responsibility and expense for the proper packing, shipment and all costs associated with the delivery of the equipment to and from the closest JVC Authorized Service Centre.		
Receivers and Home Speakers purchased separately. Front Projection and Car Audio "ARSENAL" Series	2	2
AC Adapters, Remote controls, Headphones, Microphones and Projector lamps	90 days	90 days
Wood Cone Speakers	5	5
All Other Categories	1	1

JVCKENWOOD CANADA INC.

6070 Kestrel Road, Mississauga, Ontario, L5T 1S8 Canada
TEL: (905) 670-3381 FAX: (905) 670-7244 Service toll free #: 1-800-964-2650
http://www.jvc.ca E-mail: service@jvc.ca

Product Registration

We suggest that you register your product since it will enable us to contact you directly if it is ever necessary to correct a safety related condition in your product. You can register at <http://www.jvc.ca/www/Support/Warranty.aspx>

For customer use:

Enter below the Model No. and Serial No. which is located either on the rear, bottom or side of the cabinet. Retain this information for future reference.

Model No.: _____ Serial No.: _____
Purchase date: _____ Name of dealer: _____

GARANTIE

La garantie s'applique seulement aux PRODUITS distribués au Canada par JVCKENWOOD CANADA INC.

JVCKENWOOD CANADA INC. (ci-après appelé "JVC") énonce la garantie expresse suivante pour tout nouveau produit JVC distribué au Canada par JVC et vendu par un détaillant JVC autorisé. JVC vous garantit que ce produit est déposé, sous utilisation et entretien normal, de tout défaut matériel et de fabrication sous réserve des modalités et conditions suivantes:

1. Pour obtenir un service de garantie:

- Les produits JVC nécessitant un service doit être présentée avec la preuve d'achat.
- Le produit JVC doit être apporté pour service chez un centre de service JVC autorisé.

2. Restrictions:

Cette garantie ne s'applique pas aux:

- Réparation ou remplacement de tout cabinet, batteries, panneau avant, cordons de raccord, antennes, housses de protection, boutons, couverts de hautparleur, cônes de hautparleur, écrans de projection, protecteurs d'écran de projection et tous les accessoires.
- Tous défauts occasionnés ou réparations requises suite à une utilisation abusive, mauvaise, négligente et/ou une utilisation incorrecte.
- Tous défauts occasionnés ou réparations requises suite à l'omission de suivre les recommandations du manuel d'instruction.
- Tout produit JVC altéré, ajusté ou réparé par tout autre entreprise que JVC ou un centre de service d'entretien ou de service autorisé JVC.
- Tout produit JVC dont le numéro de série a été altéré, modifié ou enlevé.
- L'entretien, les vérifications périodiques et nettoyage.
- La conversion à une fréquence ou une tension étrangère ou domestique.
- Tout produit JVC n'ayant pas le signe d'identification qui conforme aux normes électriques Canadiennes (CSA).
- Pour tout produit utilisé à des fins commerciales, institutionnelles, de location ou utilisé à des fins d'étalage. Pièces 1 An (Excepté les têtes vidéo- 90 jours)
Main d'oeuvre ... 90 Jours
- Tout produit JVC ayant été revendu et qui n'est plus la propriété de l'acheteur original.
- Produit acheté à "l'extérieur du Canada", provenant d'une "faillite" ou d'un "liquidateur".
- Tout dommage causé par le feu, une inondation, un éclair, une surtension ou tout autre événement hors du contrôle de JVC.

(m) POUR LES PRODUITS D'AUTOMOBILE

La garantie ne couvre pas l'élimination d'interférences statiques ou électriques de la voiture, le nettoyage de tête, les ajustements et les coûts de main d'œuvre associés à l'enlèvement ou à la réinstallation de l'unité pour réparation.

3. Critères:

Si un produit JVC s'avérait défectueux, selon les conditions applicables, les réparations nécessaires seront effectués sans coûts additionnels à l'acheteur pour les pièces et la main d'œuvre lorsque JVC reconnaît que de tels défauts sont causés par une défectuosité de matériel ou de fabrication.

4. Exclusion de toutes autres garanties expresses :

Cette garantie constitue l'entière garantie expresse donnée par JVC pour les produits JVC. Nul représentant ou employé d'un détaillant ou d'un service d'entretien n'est autorisé à prolonger cette garantie au nom de JVC.

5. Dénégation des dommages indirects:

Dans la mesure permise par la loi, JVC nie toute responsabilité pour perte de temps ou d'usage de ses produits, des coûts de transport ou tout autre dommage ou inconvénient indirect, accidentel et conséquent.

CONDITIONS DE GARANTIE (VALABLE À PARTIR DE LA DATE D'ACHAT)

Produit	Pièces (Années)	Main-D'oeuvre (Années)
Écrans de projection Service à Domicile Écrans de TV Couleur Service à Domicile (25" et plus) TV projection arrière D-ILA Service à Domicile Écrans de LCD Service à Domicile (25" et plus)	1	1
* Service à domicile fourni par un détaillant disponible. S'il n'y a pas de service JVC disponible à proximité, l'acheteur doit assumer la responsabilité et les coûts pour un emballage adéquat, l'expédition, ainsi que tous les coûts associés à la livraison de l'équipement chez et depuis le détaillant JVC autorisé le plus près pour un service d'entretien.		
Récepteurs et Hauts-Parleurs achetés séparément, Projecteur Avant et Audio d'Auto de Série "ARSENAL"	2	2
Adaptateurs AC, Télécommande, Casque D'écoute, Microphones et Lampe de Projecteur	90 Jours	90 Jours
Enceinte à Cône en Bois	5	5
Toutes les autres catégories	1	1

JVCKENWOOD CANADA INC.

6070 Kestrel Road, Mississauga, Ontario, L5T 1S8 Canada
TEL: (905) 670-3381 FAX: (905) 670-7244 Service toll free #: 1-800-964-2650
http://www.jvc.ca E-mail: service@jvc.ca

Enregistrement du produit

Nous vous conseillons d'enregistrer votre produit, car il nous permettra de vous contacter directement si jamais elle est nécessaire pour corriger un problème lié à la sécurité de votre produit. Vous pouvez vous inscrire à <http://www.jvc.ca/www/Support/Warranty.aspx>

Pour l'utilisation des clients:

Entrez ci-dessous le numéro de modèle et le numéro de série qui se trouve soit à l'arrière, en bas ou sur le côté de l'armoire. Conservez ces informations pour référence future.

No. de modèle: _____ No. de série: _____
Date d'achat: _____ Nom du revendeur: _____