



ENGLISH
FRANÇAIS
ESPAÑOL

KD-R690S / KD-R492 / KD-R490

CD RECEIVER
INSTRUCTION MANUAL

RÉCEPTEUR CD
MANUEL D'INSTRUCTIONS

RECEPTOR CON CD
MANUAL DE INSTRUCCIONES

JVCKENWOOD Corporation

pandora[®]

(((SiriusXM)))
READY



For customer Use:

Enter below the Model No. and Serial No. which are located on the top or bottom of the cabinet. Retain this information for future reference.

Model No. _____
Serial No. _____

CONTENTS

BEFORE USE	2
BASICS	3
GETTING STARTED	4
1 Cancel the demonstration	
2 Set the clock and date	
3 Set the basic settings	
RADIO	5
CD/USB/iPod/ANDROID	8
Pandora®	10
SiriusXM® Radio	11
AUX	14
AUDIO SETTINGS	14
DISPLAY SETTINGS	17
REFERENCES	18
Maintenance	
More information	
TROUBLESHOOTING	20
INSTALLATION/ CONNECTION	22
SPECIFICATIONS	25

BEFORE USE

IMPORTANT

- To ensure proper use, please read through this manual before using this product. It is especially important that you read and observe Warning and Caution in this manual.
- Please keep the manual in a safe and accessible place for future reference.

⚠ WARNING

- **Do not operate any function that takes your attention away from safe driving.**
- **Do not ingest the battery, Chemical Burn Hazard**
The remote control supplied with this product contains a coin/button cell battery.
If the coin/button cell battery is swallowed, it can cause severe internal burns in just 2 hours and can lead to death.
Keep new and used batteries away from children.
If the battery compartment does not close securely, stop using the product and keep it away from children.
If you think batteries might have been swallowed or placed inside any part of the body, seek immediate medical attention.

⚠ Caution

Volume setting:

- Adjust the volume so that you can hear sounds outside the car to prevent accidents.
- Lower the volume before playing digital sources to avoid damaging the speakers by the sudden increase of the output level.

General:

- Avoid using the external device if it might hinder safe driving.
- Make sure all important data has been backed up. We shall bear no responsibility for any loss of recorded data.
- Never put or leave any metallic objects (such as coins or metal tools) inside the unit, to prevent a short circuit.
- If a disc error occurs due to condensation on the laser lens, eject the disc and wait for the moisture to evaporate.
- Depending on the types of cars, the antenna will automatically extend when you turn on the unit with the antenna control wire connected (→ 24). Turn off the unit when parking at a low ceiling area.

Remote control (RM-RK52):

- Do not leave the remote control in hot places such as on the dashboard.
- The Lithium battery is in danger of explosion if replaced incorrectly. Replace it only with the same or equivalent type.
- The battery pack or batteries shall not be exposed to excessive heat such as sunshine, fire or the like.

How to read this manual

- Operations are explained mainly using buttons on the faceplate of **KD-R690S**.
- English indications are used for the purpose of explanation. You can select the display language from the menu. (→ 5)
- [XX] indicates the selected items.
- (→ XX) indicates references are available on the stated page.

BASICS

Faceplate

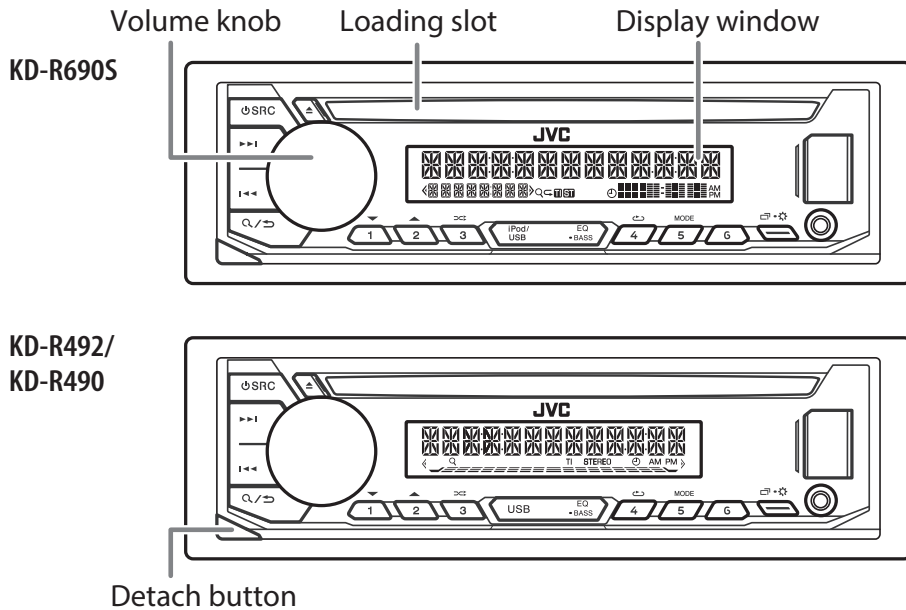

Attach

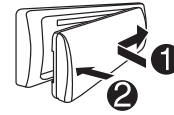

Detach

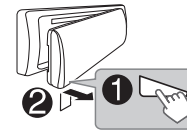

How to reset

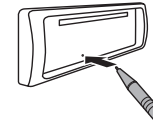

Your preset adjustments will be erased except stored radio stations.

Remote control (RM-RK52)

Remote sensor
(Do not expose to bright sunlight.)

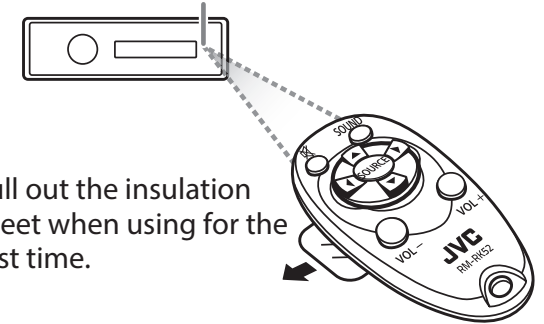

Pull out the insulation sheet when using for the first time.

How to replace the battery

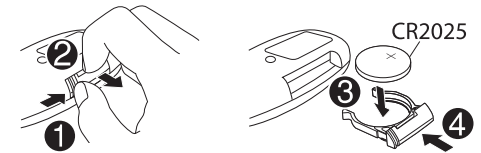

To	On the faceplate	On the remote control
Turn on the power	Press SRC . • Press and hold to turn off the power.	(Not available)
Adjust the volume	Turn the volume knob. Press the volume knob to mute the sound or pause playback. • Press again to cancel. The volume level returns to the previous level before muting or pause.	Press VOL + or VOL - . • Press and hold VOL + to continuously increase the volume to 15. Press MUTE to mute the sound or pause playback. • Press again to cancel. The volume level returns to the previous level before muting or pause.
Select a source	• Press SRC repeatedly. • Press SRC , then turn the volume knob within 2 seconds.	Press SOURCE repeatedly.
Change the display information	Press INFO repeatedly. (→ 19, 20)	(Not available)

GETTING STARTED

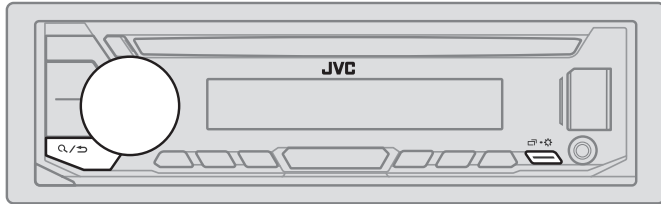

1 Cancel the demonstration

When you turn on the power (or after you reset the unit), the display shows: "CANCEL DEMO" → "PRESS" → "VOLUME KNOB"

- 1 Press the volume knob.
[YES] is selected for the initial setup.
- 2 Press the volume knob again.
"DEMO OFF" appears.

2 Set the clock and date

- 1 Press and hold .
 - 2 Turn the volume knob to select [CLOCK], then press the knob.
- To adjust the clock**
- 3 Turn the volume knob to select [CLOCK ADJUST], then press the knob.
 - 4 Turn the volume knob to make the settings, then press the knob.
Hour → Minute
 - 5 Turn the volume knob to select [CLOCK FORMAT], then press the knob.
 - 6 Turn the volume knob to select [12H] or [24H], then press the knob.

To set the date

- 7 Turn the volume knob to select [DATE SET], then press the knob.
- 8 Turn the volume knob to make the settings, then press the knob.
Day → Month → Year
- 9 Press to exit.

To return to the previous setting item, press .

3 Set the basic settings

- 1 Press and hold .
- 2 Turn the volume knob to select an item (see the following table), then press the knob.
- 3 Repeat step 2 until the desired item is selected or activated.
- 4 Press to exit.

To return to the previous setting item, press .

Default: XX

SYSTEM	
KEY BEEP	<u>ON</u> : Activates the keypress tone. ; <u>OFF</u> : Deactivates.
SOURCE SELECT	
AM SRC*	<u>ON</u> : Enables AM in source selection. ; <u>OFF</u> : Disables. (→ 5)
PANDORA SRC*	(For KD-R690S) <u>ON</u> : Enables PANDORA in source selection. ; <u>OFF</u> : Disables. (→ 10)
BUILT-IN AUX*	<u>ON</u> : Enables AUX in source selection. ; <u>OFF</u> : Disables. (→ 14)
F/W UPDATE	
UPDATE SYSTEM	
F/W UP xxxx	<u>YES</u> : Starts upgrading the firmware. ; <u>NO</u> : Cancels (upgrading is not activated). For details on how to update the firmware, visit: < http://www.jvc.net/cs/car/ >.

* Not displayed when the corresponding source is selected.

GETTING STARTED

CLOCK	
TIME SYNC	ON: The clock time is automatically set using the Clock Time (CT) data in FM Radio Broadcast Data System signal/FM Radio Data System signal. ; OFF: Cancels.
CLOCK DISPLAY	ON: The clock time is shown on the display even when the unit is turned off. ; OFF: Cancels.
ENGLISH	Select the display language for menu and music information if applicable.
ESPAÑOL	By default, ENGLISH is selected.

RADIO

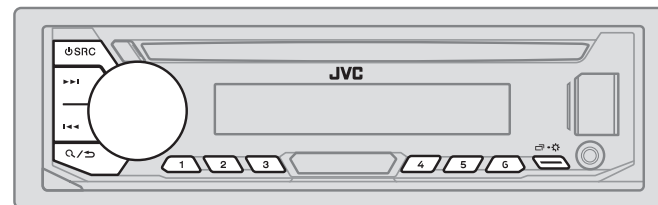

“ST” or “STEREO” lights up when receiving an FM stereo broadcast with sufficient signal strength.

Search for a station

- 1 Press **SRC** repeatedly to select FM or AM.
- 2 Press **◀◀ / ▶▶** (or press **◀ / ▶** on the remote control) to search for a station automatically.
(or)
Press and hold **◀◀ / ▶▶** (or press and hold **◀ / ▶** on the remote control) until “M” flashes, then press repeatedly to search for a station manually.

Settings in memory

You can store up to 18 stations for FM and 6 stations for AM.

■ Store a station

While listening to a station...

Press and hold one of the number buttons (1 to 6).

(or)

- 1 Press and hold the volume knob until “PRESET MODE” flashes.
- 2 Turn the volume knob to select a preset number, then press the knob.
The preset number flashes and “MEMORY” appears.

RADIO

Select a stored station

Press one of the number buttons (1 to 6).

(or)

- 1 Press **Q** / **↵**.
- 2 Turn the volume knob to select a preset number, then press the knob.

Other settings

- 1 Press and hold **☰** · **⊗**.
- 2 Turn the volume knob to select an item (see the following table), then press the knob.
- 3 Repeat step 2 until the desired item is selected/activated or follow the instructions stated on the selected item.
- 4 Press **☰** · **⊗** to exit.

To return to the previous setting item, press **Q** / **↵**.

Default: **XX**

TUNER SETTING (for KD-R690S/KD-R490)

RADIO TIMER	<p>Turns on the radio at a specific time regardless of the current source.</p> <ol style="list-style-type: none"> 1 ONCE/DAILY/WEEKLY/OFF: Select how often the timer will be turned on. 2 FM/AM/SIRIUS XM*1: Select the source. 3 01 to 18 (for FM/SIRIUS XM)/01 to 06 (for AM): Select the preset station. 4 Set the activation day*2 and time. “⊗” lights up when complete. <p>Radio Timer will not activate for the following cases.</p> <ul style="list-style-type: none"> • The unit is turned off. • [OFF] is selected for [AM SRC] in [SOURCE SELECT] after Radio Timer for AM is selected. (➔ 4)
--------------------	--

SSM	SSM 01–06/SSM 07–12/SSM 13–18 : Automatically presets up to 18 stations for FM. “SSM” stops flashing when the first 6 stations are stored. Select SSM 07–12/SSM 13–18 to store the following 12 stations.
IF BAND	AUTO : Increases the tuner selectivity to reduce interference noises from adjacent FM stations. (Stereo effect may be lost.) ; WIDE : Subjects to interference noises from adjacent FM stations, but sound quality will not be degraded and the stereo effect will remain.
MONO SET	ON : Improves the FM reception, but the stereo effect will be lost. ; OFF : Cancels.
AREA	N.AMERICA : For North/Central/South America, AM/FM intervals: 10 kHz/200 kHz. ; S.AMERICA : For some South American countries, AM/FM intervals: 10 kHz/50 kHz. ; EUROPE : For any other areas, AM/FM intervals: 9 kHz/50 kHz.
PTY SEARCH *3	Select a PTY code (see below). If there is a station broadcasting a program of the same PTY code as you have selected, that station is tuned in.

*1 For **KD-R690S**: Selectable only when SiriusXM Vehicle Tuner is connected. (➔ 11)

*2 Selectable only when **[ONCE]** or **[WEEKLY]** is selected in step 1.

*3 Only for FM source.

PTY code (for KD-R690S/KD-R490)

NEWS, INFORM (information), **SPORTS, TALK, ROCK, CLS ROCK** (classic rock), **ADLT HIT** (adult hits), **SOFT RCK** (softrock), **TOP 40, COUNTRY, OLDIES, SOFT, NOSTALGA** (nostalgia), **JAZZ, CLASSICL** (classical), **R & B** (rhythm and blues), **SOFT R&B** (soft rhythm and blues), **LANGUAGE, REL MUSC** (religious music), **REL TALK** (religious talk), **PERSNLTY** (personality), **PUBLIC, COLLEGE, HABL ESP** (Spanish talk), **MUSC ESP** (Spanish music), **HIP HOP, WEATHER**

RADIO

Default: **XX**

TUNER SETTING (for KD-R492)	
RADIO TIMER	<p>Turns on the radio at a specific time regardless of the current source.</p> <ol style="list-style-type: none"> ONCE/DAILY/WEEKLY/OFF: Select how often the timer will be turned on. FM/AM: Select the band. 01 to 18 (for FM)/01 to 06 (for AM): Select the preset station. Set the activation day*¹ and time. “⌚” lights up when complete. <p>Radio Timer will not activate for the following cases.</p> <ul style="list-style-type: none"> The unit is turned off. [OFF] is selected for [AM SRC] in [SOURCE SELECT] after Radio Timer for AM is selected. (➡ 4)
SSM	<p>SSM 01–06/SSM 07–12/SSM 13–18: Automatically presets up to 18 stations for FM. “SSM” stops flashing when the first 6 stations are stored. Select SSM 07–12/SSM 13–18 to store the following 12 stations.</p>
IF BAND	<p>AUTO: Increases the tuner selectivity to reduce interference noises from adjacent FM stations. (Stereo effect may be lost.) ; WIDE: Subjects to interference noises from adjacent FM stations, but sound quality will not be degraded and the stereo effect will remain.</p>
MONO SET	<p>ON: Improves the FM reception, but the stereo effect will be lost. ; OFF: Cancels.</p>
NEWS SET * ²	<p>ON: The unit will temporarily switch to News Programme if available. ; OFF: Cancels.</p>
REGIONAL * ²	<p>ON: Switches to another station only in the specific region using the “AF” control. ; OFF: Cancels.</p>
AF SET * ²	<p>ON: Automatically searches for another station broadcasting the same program in the same Radio Data System network with better reception when the current reception is poor. ; OFF: Cancels.</p>

TI	<p>ON: Allows the unit to temporarily switch to Traffic Information if available (“TI” lights up) while listening to all sources except in AM. ; OFF: Cancels.</p>
AREA	<p>N.AMERICA: For North/Central/South America, AM/FM intervals: 10 kHz/200 kHz. ; S.AMERICA: For some South American countries, AM/FM intervals: 10 kHz/50 kHz. ; EUROPE: For any other areas, AM/FM intervals: 9 kHz/50 kHz.</p>
PTY SEARCH * ²	<p>Select a PTY code (see below). If there is a station broadcasting a program of the same PTY code as you have selected, that station is tuned in.</p>

*¹ Selectable only when **[ONCE]** or **[WEEKLY]** is selected in step **1**.

*² Only for FM source.

PTY code (for KD-R492)

NEWS, AFFAIRS, INFO, SPORT, EDUCATE, DRAMA, CULTURE, SCIENCE, VARIED, POP M (music), ROCK M (music), EASY M (music), LIGHT M (music), CLASSICS, OTHER M (music), WEATHER, FINANCE, CHILDREN, SOCIAL, RELIGION, PHONE IN, TRAVEL, LEISURE, JAZZ, COUNTRY, NATION M (music), OLDIES, FOLK M (music), DOCUMENT

CD/USB/iPod/ANDROID

Start playback

The source changes automatically and playback starts.

CD

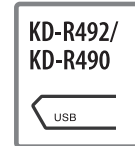
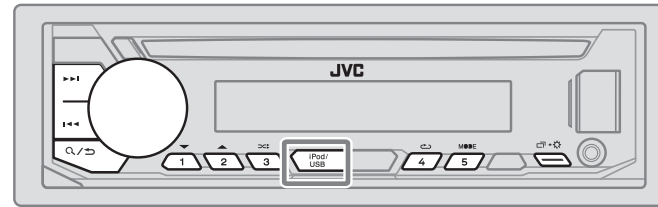
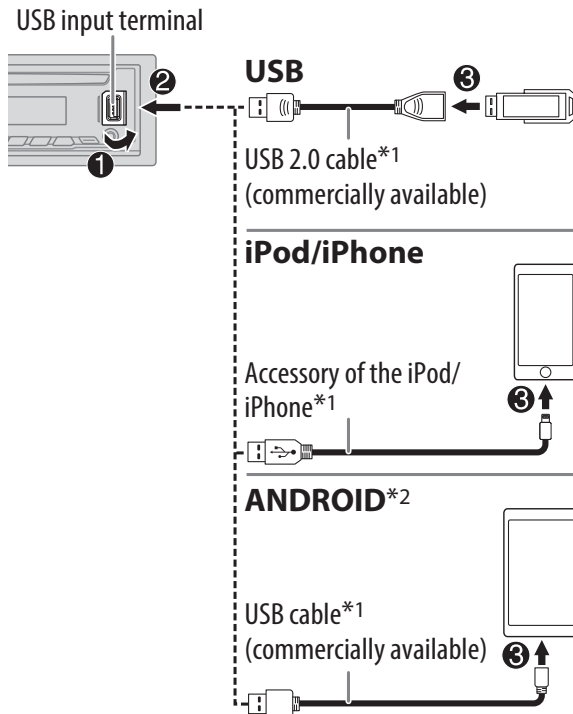
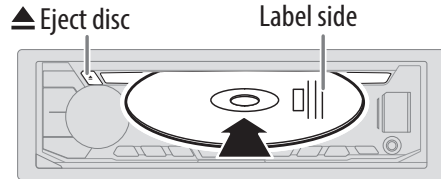

Selectable source:

KD-R690S: CD/USB/iPod/ANDROID

KD-R492/KD-R490: CD/USB/ANDROID

- To directly select USB/iPod/ANDROID source, press **iPod/USB** or **USB**.

To	On the faceplate	On the remote control
Reverse/Fast-forward*3	Press and hold ◀◀ / ▶▶ .	Press and hold ◀/▶.
Select a track/file	Press ◀◀ / ▶▶ .	Press ◀/▶.
Select a folder*4	Press 2 ▲ / 1 ▼.	Press ▲ / ▼.
Repeat play*5	Press 4 ↺ repeatedly. TRACK REPEAT/ALL REPEAT : Audio CD TRACK REPEAT/FOLDER REPEAT/ALL REPEAT : MP3/WMA/WAV/FLAC file ONE REPEAT/ALL REPEAT/REPEAT OFF : iPod or ANDROID	
Random play*5	Press 3 ↻ repeatedly. ALL RANDOM/RANDOM OFF : Audio CD FOLDER RANDOM/ALL RANDOM/RANDOM OFF : MP3/WMA/WAV/FLAC file SONG RANDOM/ALL RANDOM/RANDOM OFF : iPod or ANDROID	

*1 Do not leave the cable inside the car when not using.

*2 When connecting an Android device, "Press [VIEW] to install JVC MUSIC PLAY APP" is shown. Follow the instructions to install the application. You can also install the latest version of JVC MUSIC PLAY application on your Android device before connecting. For more information, visit <<http://www.jvc.net/cs/car/>>.

*3 For ANDROID: Applicable only when [AUTO MODE] is selected. (→ 9)

*4 For CD: Only for MP3/WMA files. This does not work for iPod/ANDROID.

*5 For iPod/ANDROID: Applicable only when [HEAD MODE]/[AUTO MODE] is selected. (→ 9)

CD/USB/iPod/ANDROID

Select control mode

While in iPod source, press **5 MODE** repeatedly.

HEAD MODE : Control iPod from this unit.

IPHONE MODE : Control iPod using the iPod itself. However, you can still play/pause or file skip from this unit.

While in ANDROID source, press **5 MODE** repeatedly.

AUTO MODE : Control Android device from this unit via JVC MUSIC PLAY application installed in the Android device.

AUDIO MODE : Control Android device using the Android device itself via other media player applications installed in the Android device. However, you can still play/pause or file skip from this unit.

Select music drive

While in USB source, press **5 MODE** repeatedly.

Stored songs in the following drive will be played back.

- Selected internal or external memory of a smartphone (Mass Storage Class).
- Selected drive of a multiple drives device.

Select a file from a folder/list

For iPod/ANDROID, applicable only when [HEAD MODE]/[AUTO MODE] is selected.

- 1 Press **Q/↵**.
- 2 Turn the volume knob to select a folder/list, then press the knob.
- 3 Turn the volume knob to select a file, then press the knob.

Quick search (applicable only for CD, USB, and ANDROID source)
If you have many files, you can search through them quickly.

Turn the volume knob quickly to browse through the list quickly.

Alphabet search (applicable only for iPod and ANDROID source)
You can search for a file according to the first character.

For iPod source

Press **2 ▲ / 1 ▼** or turn the volume knob quickly to select the desired character (A to Z, 0 to 9, OTHERS).

- Select "OTHERS" if the first character is other than A to Z, 0 to 9.

For ANDROID source

1 Press **2 ▲ / 1 ▼** to enter character search.

2 Turn the volume knob to select the desired character.

^A^ : Upper case letters (A to Z)

A : Lower case letters (a to z)

-0- : Numbers (0 to 9)

-OTHERS- : Character other than A to Z, 0 to 9

3 Press the volume knob to start searching.

- To return to the previous setting item, press **Q/↵**.
- To cancel, press and hold **Q/↵**.

Pandora® (for KD-R690S)

Preparation:

Install the latest version of the Pandora application on your device (iPhone/iPod touch), then create an account and log in to Pandora.



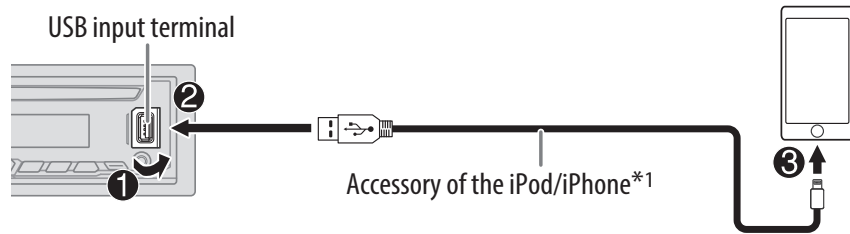

- Select [ON] for [PANDORA SRC] in [SOURCE SELECT]. (→ 4)

Start listening

- 1 Open the Pandora application on your device.
- 2 Connect your device to the USB input terminal.



The source changes to PANDORA and broadcast starts.

To	On the faceplate	On the remote control
Playback/pause	Press the volume knob.	Press  .
Skip a track	Press  .	Press  .
Thumbs up or thumbs down*2	Press 2 ▲ / 1 ▼ .	Press  /  .

*1 Do not leave the cable inside the car when not using.

*2 If thumbs down is selected, the current track is skipped.

Create and store a new station

- 1 Press .
- 2 Turn the volume knob to select [NEW STATION], then press the knob.
- 3 Turn the volume knob to select [FROM TRACK] or [FROM ARTIST], then press the knob.

A new station is created based on the current song or artist.

- 4 Press and hold one of the number buttons (**3**, **4**, **5** or **6**) to store.

To select a stored station: Press one of the number buttons (**3**, **4**, **5** or **6**).

Search for a registered station

- 1 Press .
- 2 Turn the volume knob to select an item, then press the knob.
[BY DATE] : According to the registered date
[A-Z] : By alphabetical order
- 3 Turn the volume knob to select the desired station, then press the knob.

To cancel, press and hold .

Bookmark current song information

Press and hold the volume knob.

"BOOKMARKED" appears and the information is stored to your device.

- The bookmark is available on your Pandora account but not on this unit.

SiriusXM® Radio (for KD-R690S)

Only SiriusXM® brings you more of what you love to listen to, all in one place. Get over 140 channels, including commercial-free music plus the best sports, news, talk, comedy and entertainment. Welcome to the world of satellite radio. A SiriusXM Vehicle Tuner and Subscription are required. For more information, visit <www.siriusxm.com>.

Preparation:

- 1 Connect the optional SiriusXM Vehicle Tuner (commercially available).

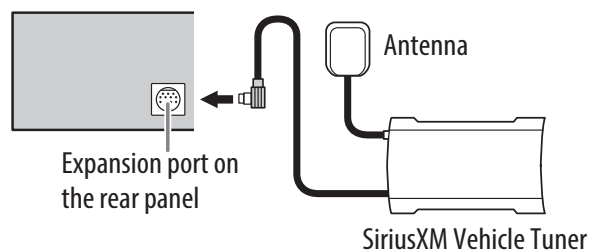

- 2 Check your Radio ID for activation.

The SiriusXM Radio ID is required for activation and can be found by tuning to Channel 0 as well as on the label found on the SiriusXM Vehicle tuner and its packaging.

The Radio ID does not include the letters I, O, S or F.

- 3 Activate the subscription.

For users in U.S.A.:

Online: Go to <www.siriusxm.com>

Phone: Call 1-866-635-2349

For users in Canada:

Online: Go to <www.siriusxm.ca/activatexm>

Phone: Call 1-877-438-9677

- 4 Press **SRC** repeatedly to select SIRIUS XM to start updating.

Start listening

- 1 Press **SRC** repeatedly to select SIRIUS XM.
- 2 Press **Q/↵**.
"Q" lights up.
- 3 Turn the volume knob to select a CATEGORY, then press the knob.
- 4 Turn the volume knob to select a category from the list, then press the knob.
If "ALL CHANNEL" is selected, all the available channels will be shown.
- 5 Turn the volume knob to select a channel, then press the knob.
(or)
Press **◀◀ / ▶▶** to search for a channel manually.
 - Pressing and holding **◀◀ / ▶▶** changes the channel rapidly.

If a locked channel or a mature channel is selected, a pass code input screen appears. Enter the pass code to receive the channel. (→ 13)

Settings in memory

You can store up to 18 channels.

Store a channel

While listening to a channel...

Press and hold one of the number buttons (1 to 6).

(or)

- 1 Press and hold the volume knob until "PRESET MODE" flashes.
- 2 Turn the volume knob to select a preset number, then press the knob.
The preset number flashes and "MEMORY" appears.

Select a stored channel

Press one of the number buttons (1 to 6).

(or)

- 1 Press **Q/↵**.
- 2 Turn the volume knob to select PRESET, then press the knob.
- 3 Turn the volume knob to select a preset number, then press the knob.
(or)

Press **▲ / ▼** on the remote control.











SiriusXM® Radio (for KD-R690S)

SiriusXM Replay™

While listening to a channel....

- 1 Press the volume knob.**
“↶” lights up and the unit memorizes this paused position.
- 2 Press the volume knob to start Replay.**
Replay starts from the paused position in step 1.

During Replay...

To	On the faceplate	On the remote control
Playback/pause	Press the volume knob.	Press  .
Skip backward/ forward	Press   .	Press  /  .
Rewind/Fast-forward	Press and hold   .	Press and hold  /  .
Go to Live and exit Replay	Press and hold the volume knob. <ol style="list-style-type: none">1 Press .2 Turn the volume knob to select LIVE, then press the knob.	Press and hold  .

SmartFavorites and TuneStart™

User preset channels are initially assigned as the SmartFavorites channels. SmartFavorite channel is available with SXV200 or later SiriusXM tuner models. SiriusXM Vehicle Tuner automatically buffers the broadcast audio content of the SmartFavorites channels in the background.



Using SXV200: This unit can assign a maximum of 6 SmartFavorites channels. If you try to assign the 7th channel, an error beep tone will be heard. Initially, preset channels 1 to 6 are assigned as SmartFavorites.

Using SiriusXM tuner models later than SXV200: This unit can assign a maximum of 18 SmartFavorites channels. Initially, all preset channels are assigned as SmartFavorites.

- “*” appears at the last character of the channel name for the SmartFavorites channels.

When you select a SmartFavorites channel, you can rewind and replay up to 30 minutes of any of the missed news, talk, sports or music content.

- Playback starts from the beginning of the song if [TUNE START] is set to [ON] (➔ 13) for most music channels stored as a SmartFavorite.

To	On the faceplate
Select a stored SmartFavorite channel	Press one of the number buttons (1 to 6). <ol style="list-style-type: none">1 Press .2 Turn the volume knob to select PRESET, then press the knob.3 Turn the volume knob to select a preset number, then press the knob.
Cancel SmartFavorites channels	<ol style="list-style-type: none">1 Press .2 Turn the volume knob to select PRESET, then press the knob.3 Turn the volume knob to select a preset number, then press and hold the knob. “*” is removed from the last character.
Reassign SmartFavorites channels	Repeat steps 1 to 3 of cancelling SmartFavorites channels. “*” appears at the last character.

SiriusXM® Radio (for KD-R690S)

TuneScan™

You can get a short preview of the songs that you have missed on each of your SmartFavorite music channels or current tuned music channel.

- 1 Press **Q** / **↵**.
 - 2 Turn the volume knob to select **TUNE SCAN**, then press the knob.
Scanning start for the first 6 seconds of the recorded music contents.
- To listen to the current song, press the volume knob to stop scanning. The unit continues playing the current song.
 - To select the previous/next song, press **◀◀** / **▶▶**.
 - To cancel scanning, press and hold the volume knob. Playback returns to the channel before you enter TuneScan.

SiriusXM settings

- 1 Press and hold **☰** · **⚙**.
- 2 Turn the volume knob to select an item (see the following table), then press the knob.
- 3 Repeat step 2 until the desired item is selected/activated or follow the instructions stated on the selected item.
- 4 Press **☰** · **⚙** to exit.

To return to the previous setting item, press **Q** / **↵**.

Default: **XX**

SIRIUS XM

- CHANNEL LOCK** To unlock settings:
- 1 Turn the volume knob to select a number.
 - 2 Press **◀◀** / **▶▶** to move to the entry position.
 - 3 Repeat steps 1 and 2 to enter the current pass code.
(Initial pass code is 0000.)
 - 4 Press the volume knob to confirm.

CODE SET	<ol style="list-style-type: none"> 1 Press the volume knob to enter [NEW CODE]. 2 Turn the volume knob to select a number. 3 Press ◀◀ / ▶▶ to move to the entry position. 4 Repeat steps 2 and 3 to enter a new 4-digit pass code. 5 Press the volume knob to confirm. 6 Repeat steps 2 to 5 to reconfirm the pass code. <ul style="list-style-type: none"> • Make a note of the new pass code to enter channel lock settings for next time.
LOCK SETTING	<p>MATURE CH: Selects the SiriusXM-defined lock setting. ;</p> <p>USER DEFINED: Selects the individual channels the user wants to lock. ; OFF: Cancels.</p>
CHANNEL EDIT*1	<ol style="list-style-type: none"> 1 Turn the volume knob to select a category, then press the knob. 2 Turn the volume knob to select a channel you want to lock, then press the knob. “L” appears in front of the channel number. 3 Press and hold Q / ↵ to exit.
CHANNEL CLEAR*1	<p>YES: Clears all the locked channels. ; NO: Cancels.</p>
TUNE START*2	<p>ON: All qualified music channels in the SmartFavorites will start playback from the beginning of the song. ; OFF: Cancels.</p>
SIGNAL LEVEL	Shows the strength (NO SIGNAL/WEAK/GOOD/STRONG) of the current received signal.
BUFFER USAGE	Shows the memory usage (0% to 100%) for Replay buffer.
SXM RESET	YES: Resets stored channel and lock setting to default. ; NO: Cancels.

*1 Displayed only when [USER DEFINED] is selected.

*2 Available only if the connected SiriusXM Vehicle Tuner is SXV200 or later that supports SmartFavorites.

AUX

Use a portable audio player

- 1 Connect a portable audio player (commercially available).

3.5 mm (1/8") stereo mini plug with "L" shaped connector (commercially available)

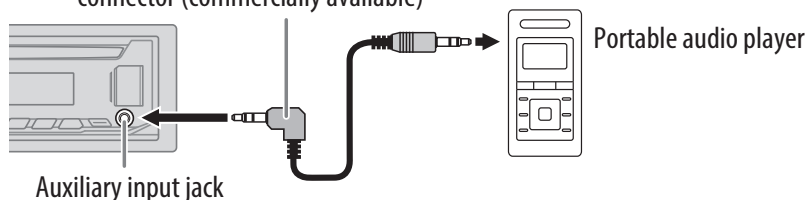

- 2 Select [ON] for [BUILT-IN AUX] in [SOURCE SELECT]. (→ 4)
- 3 Press **SRC** repeatedly to select AUX.
- 4 Turn on the portable audio player and start playback.

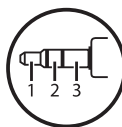

Use a 3-core plug head stereo mini plug for optimum audio output.

AUDIO SETTINGS

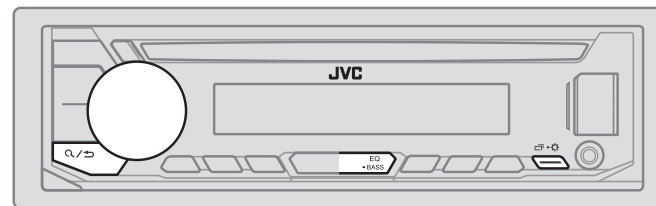

Select a preset equalizer directly

Press **EQ-BASS** repeatedly.

(or)

Press **EQ-BASS**, then turn the volume knob within 5 seconds.

Preset equalizer:

FLAT (default)/DRVN 3/DRVN 2/DRVN 1/HARD ROCK/HIP HOP/JAZZ/POP/R&B/TALK/
USER/VOCAL BOOST/BASS BOOST/CLASSICAL/DANCE

- Drive equalizer (DRVN 3/DRVN 2/DRVN 1) boosts specific frequencies in the audio signal to reduce the noise heard from outside the car or running noise of the tyres.

Store your own sound settings

- 1 Press and hold **EQ-BASS** to enter EASY EQ setting.
 - 2 Turn the volume knob to select an item, then press the knob.
Refer to [EASY EQ] (→ 15) for setting and the result is stored to [USER].
- To return to the previous setting item, press **Q/↵**.
 - To exit, press **EQ-BASS**.

Other settings

- 1 Press and hold **↵/⏏**.
- 2 Turn the volume knob to select an item (→ 15), then press the knob.
- 3 Repeat step 2 until the desired item is selected/activated or follow the instructions stated on the selected item.
- 4 Press **↵/⏏** to exit.

To return to the previous setting item, press **Q/↵**.

AUDIO SETTINGS

Default: **XX**

EQ SETTING	
PRESET EQ	Select a preset equalizer suitable to the music genre. <ul style="list-style-type: none"> Select [USER] to use the settings made in [EASY EQ] or [PRO EQ]. FLAT/DRVN 3/DRVN 2/DRVN 1/HARD ROCK/HIP HOP/JAZZ/POP/R&B/TALK/USER/VOCAL BOOST/BASS BOOST/CLASSICAL/DANCE
EASY EQ	Adjust your own sound settings. <ul style="list-style-type: none"> The settings are stored to [USER]. The settings made may affect the current settings of [PRO EQ]. SUB.W SP*1*2 : 00 to +06 (Default: +03) SUB.W*1*3 : -08 to +08 00 BASS : LVL-06 to LVL+06 LVL 00 MID : LVL-06 to LVL+06 LVL 00 TRE : LVL-06 to LVL+06 LVL 00
PRO EQ	Adjust your own sound settings. <ul style="list-style-type: none"> The settings are stored to [USER]. The settings made may affect the current settings of [EASY EQ]. 1 BASS/MIDDLE/TREBLE: Select a sound tone. 2 Adjust the sound elements of the selected sound tone. BASS Frequency : 60HZ/80HZ/100HZ/200HZ Level : LVL-06 to LVL+06 Q : Q1.0/Q1.25/Q1.5/Q2.0 (Default : 80HZ/LVL 00/Q1.0) MIDDLE Frequency : 0.5KHZ/1.0KHZ/1.5KHZ/2.5KHZ Level : LVL-06 to LVL+06 Q : Q0.75/Q1.0/Q1.25 (Default : 1.0KHZ/LVL 00/Q1.25) TREBLE Frequency : 10.0KHZ/12.5KHZ/15.0KHZ/17.5KHZ Level : LVL-06 to LVL+06 Q : Q FIX (Default : 10.0KHZ/LVL 00/Q FIX)

AUDIO CONTROL	
BASS BOOST	LEVEL +01 to LEVEL +05 (LEVEL +01): Selects your preferred bass boost level. ; OFF: Cancels.
LOUDNESS	LEVEL 01/LEVEL 02: Boosts low or high frequencies to produce a well-balanced sound at low volume. ; OFF: Cancels.
SUB.W LEVEL*1	SPK-OUT*2 SUB.W 00 to SUB.W +06 (SUB.W +03): Adjusts the output level of the subwoofer connected via speaker lead. (⇒ 24) PRE-OUT*3 SUB.W -08 to SUB.W +08 (SUB.W 00): Adjusts the output level of the subwoofer connected to the lineout terminals (REAR/SW) through an external amplifier. (⇒ 24)
SUBWOOFER SET*3	ON: Turns on the subwoofer output. ; OFF: Cancels.
SUBWOOFER LPF*1	FRQ THROUGH: All signals are sent to the subwoofer. ; FRQ 55HZ/FRQ 85HZ/FRQ 120HZ: Audio signals with frequencies lower than 55 Hz/85 Hz/120 Hz are sent to the subwoofer.
SUB.W PHASE*4	REVERSE (180°)/NORMAL (0°): Selects the phase of the subwoofer output to be in line with the speaker output for optimum performance.
FADER	POSITION R06 to POSITION F06 (POSITION 00): Adjusts the front and rear speaker output balance.
BALANCE*5	POSITION L06 to POSITION R06 (POSITION 00): Adjusts the left and right speaker output balance.

*1 Displayed only when [SUBWOOFER SET] is set to [ON].

*2 Displayed only when [SPK/PRE OUT] is set to [SUB.W/SUB.W]. (⇒ 16)

*3 Displayed only when [SPK/PRE OUT] is set to [REAR/SUB.W] or [SUB.W/SUB.W]. (⇒ 16)

*4 Selectable only if a setting other than [FRQ THROUGH] is selected for [SUBWOOFER LPF].

*5 This adjustment will not affect the subwoofer output.

AUDIO SETTINGS

VOLUME ADJUST	LEVEL –15 to LEVEL +06 (LEVEL 00): Preset the initial volume level of each source (compared to the FM volume level). Before adjustment, select the source you want to adjust. (“VOL ADJ FIX” appears if FM is selected.)
AMP GAIN	LOW POWER: Limits the maximum volume level to 25. (Select if the maximum power of each speaker is less than 50 W to prevent damaging the speakers.) ; HIGH POWER: The maximum volume level is 35.
D.T.EXPANDER (Digital Track Expander)	ON: Creates realistic sound by compensating the high-frequency components and restoring the rise-time of the waveform that are lost in audio data compression. ; OFF: Cancels.
SPK/PRE OUT	Select the appropriate setting to get the desired output. (➔ Speaker output settings)

Speaker output settings

Select the output setting for the speakers [SPK/PRE OUT], base on the speaker connection method.

Connection via lineout terminals

For connections through an external amplifier. (➔ 24)

KD-R690S/KD-R492:

Setting on [SPK/PRE OUT]	Audio signal through lineout terminal	
	FRONT	REAR/SW
REAR/REAR	Front speakers output	Rear speakers output
REAR/SUB.W (default)	Front speakers output	Subwoofer output
SUB.W/SUB.W	Front speakers output	Subwoofer output

KD-R490:

Setting on [SPK/PRE OUT]	Audio signal through lineout terminal	
	REAR/SW	
REAR/REAR	Rear speakers output	
REAR/SUB.W (default)	Subwoofer output	
SUB.W/SUB.W	Subwoofer output	

Connection via speaker leads

For connections without using an external amplifier. However, with this settings you can also enjoy the subwoofer output. (➔ 24)

Setting on [SPK/PRE OUT]	Audio signal through rear speaker lead	
	L (left)	R (right)
REAR/REAR	Rear speakers output	Rear speakers output
REAR/SUB.W	Rear speakers output	Rear speakers output
SUB.W/SUB.W	Subwoofer output	(Mute)

If [SUB.W/SUB.W] is selected:

- [FRQ 120HZ] is selected in [SUBWOOFER LPF] and [FRQ THROUGH] is not available. (➔ 15)
- [POSITION R01] is selected in [FADER] and selectable range is [POSITION R06] to [POSITION 00]. (➔ 15)

DISPLAY SETTINGS

Zone identification for brightness setting

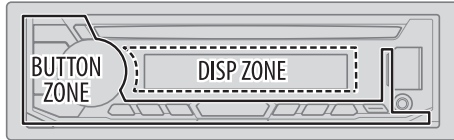

Zone identification for color setting (for KD-R690S)

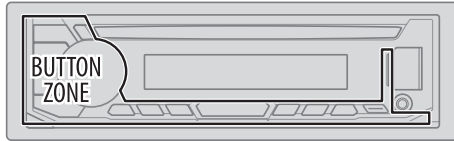

- 1 Press and hold .
- 2 Turn the volume knob to select an item (see the following table), then press the knob.
- 3 Repeat step 2 until the desired item is selected/activated or follow the instructions stated on the selected item.
- 4 Press to exit.

To return to the previous setting item, press / .

Default: **XX**

DISPLAY	
DIMMER	<p>Dim the illumination.</p> <p>OFF: Dimmer is turned off. Brightness changes to [DAY] setting.</p> <p>ON: Dimmer is turned on. Brightness changes to [NIGHT] setting. (→ [BRIGHTNESS])</p> <p>DIMMER TIME: Set the dimmer on and off time.</p> <ol style="list-style-type: none"> 1 Turn the volume knob to adjust the [ON] time, then press the knob. 2 Turn the volume knob to adjust the [OFF] time, then press the knob. (Default: [ON]: PM6:00 ; [OFF]: AM6:00) <p>DIMMER AUTO: Dimmer turns on and off automatically when you turn off or on the car headlights.*1</p>

BRIGHTNESS	<p>Set the brightness for day and night separately.</p> <ol style="list-style-type: none"> 1 DAY/NIGHT: Select day or night. 2 Select a zone. 3 LEVEL 00 to LEVEL 31: Set the brightness level.
TEXT SCROLL *2	<p>SCROLL ONCE: Scrolls the display information once. ; SCROLL AUTO: Repeats scrolling at 5-second intervals. ; SCROLL OFF: Cancels.</p>
COLOR (for KD-R690S)	
PRESET	<p>Select an illumination color for the buttons.</p> <ul style="list-style-type: none"> • COLOR 01 to COLOR 49 • USER: The color you have created for [DAY COLOR] or [NIGHT COLOR] is shown. • COLOR FLOW01 to COLOR FLOW03: Color changes at different speeds.
DAY COLOR	<p>Store your own day and night illumination colors for the buttons.</p> <ol style="list-style-type: none"> 1 RED/GREEN/BLUE: Select a primary color. 2 00 to 31: Select the level.
NIGHT COLOR	<p>Repeat steps 1 and 2 for all the primary colors.</p> <ul style="list-style-type: none"> • Your setting is stored to [USER] in [PRESET]. • [NIGHT COLOR] or [DAY COLOR] is changed by turning on or off your car's headlight.
MENU COLOR	<p>ON: The color of buttons illumination changes to white color when in menu mode or when selecting a music file from a folder/list. ;</p> <p>OFF: Cancels.</p>

*1 The illumination control wire connection is required. (→ 24)

*2 Some characters or symbols will not be shown correctly (or will be blanked).

REFERENCES

■ Maintenance

Cleaning the unit

Wipe off dirt on the faceplate with a dry silicone or soft cloth.

Cleaning the connector

Detach the faceplate and clean the connector gently with a cotton swab, being careful not to damage the connector.

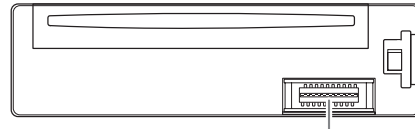

Connector (on the reverse side of the faceplate)

Handling discs:

- Do not touch the recording surface of the disc.
- Do not stick tape etc. on the disc, or use a disc with tape stuck on it.
- Do not use any accessories for the disc.
- Clean from the center of the disc and move outward.
- Clean the disc with a dry silicone or soft cloth. Do not use any solvents.
- When removing discs from this unit, pull them out horizontally.
- Remove burrs from the center hole and disc edge before inserting a disc.

■ More information

For: – Latest firmware updates and latest compatible item list
– Any other latest information

Visit <<http://www.jvc.net/cs/car/>>.

General

- This unit can only play the following CDs:



- This unit can play back multi-session discs; however, unclosed sessions will be skipped during playback.
- **DualDisc playback:** The Non-DVD side of a “DualDisc” does not comply with the “Compact Disc Digital Audio” standard. Therefore, the use of Non-DVD side of a DualDisc on this product cannot be recommended.
- For detailed information and notes about the playable audio files, visit <<http://www.jvc.net/cs/car/>>.

Playable files

- Playable audio file:
 - For disc: MP3 (.mp3), WMA (.wma)
 - For USB mass storage class device: MP3 (.mp3), WMA (.wma), WAV (.wav), FLAC (.flac)
- Playable disc media: CD-R/CD-RW/CD-ROM
- Playable disc file format: ISO 9660 Level 1/2, Joliet, Long file name.
- Playable USB device file system: FAT12, FAT16, FAT32

Even when audio files comply with the standards listed above, playback may be impossible depending on the types or conditions of media or device.

Unplayable discs

- Discs that are not round.
- Discs with coloring on the recording surface or discs that are dirty.
- Recordable/ReWritable discs that have not been finalized.
- 8 cm CD. Attempting to insert using an adapter may cause malfunction.

About USB devices

- You cannot connect a USB device via a USB hub.
- Connecting a cable whose total length is longer than 5 m may result in abnormal playback.
- This unit cannot recognize a USB device whose rating is other than 5 V and exceeds 1 A.

About iPod/iPhone

Made for

- iPod touch (2nd, 3rd, 4th, 5th, and 6th generation)
- iPod classic
- iPod nano (3rd, 4th, 5th, 6th, and 7th generation)
- iPhone 3G, 3GS, 4, 4S, 5, 5S, 5C, 6, 6 Plus, 6S, 6S Plus, SE, 7, 7 Plus
- It is not possible to browse video files on the “Videos” menu in [HEAD MODE].
- The song order displayed on the selection menu of this unit may differ from that of the iPod/iPhone.
- Depending on the version of the operating system of the iPod/iPhone, some functions may not operate on this unit.

REFERENCES

About Android device

- This unit supports Android OS 4.1 and above.
- Some Android devices (with OS 4.1 and above) may not fully support Android Open Accessory (AOA) 2.0.
- If the Android device supports both mass storage class device and AOA 2.0, this unit always playback via AOA 2.0 as priority.

About Pandora

- Pandora is only available in certain countries. For more information, visit <<http://www.pandora.com/legal>>.
- Because Pandora is a third-party service, the specifications are subject to change without prior notice. Accordingly, compatibility may be impaired, or some or all of the services may become unavailable.
- Some functions of Pandora cannot be operated from this unit.
- For issues using the application, please contact Pandora at pandora-support@pandora.com.

Change the display information

Each time you press  , the display information changes.

- If the information is unavailable or not recorded, "NO TEXT", "NO NAME", or other information (eg. station name) appears or display will be blank.

Source name	Display information (for KD-R690S)
FM or AM	Frequency (Date/Clock) (For FM Radio Broadcast Data System stations only) Station name (PS)/Program type (PTY) (Date/Clock) → Radio text (Date/Clock) → Radio text+ (Radio text+) → Song title (Artist) → Song title (Date/Clock) → Frequency (Date/Clock) → (back to the beginning)

Source name	Display information (for KD-R690S)
CD or USB	(For CD-DA) Track title (Artist) → Track title (Disc name) → Track title (Date/Clock) → Playing time (Date/Clock) → (back to the beginning) (For MP3/WMA/WAV/FLAC files) Song title (Artist) → Song title (Album name) → Song title (Date/Clock) → File name (Folder name) → File name (Date/Clock) → Playing time (Date/Clock) → (back to the beginning)
iPod or ANDROID	When [HEAD MODE]/[AUTO MODE] is selected (→ 9): Song title (Artist) → Song title (Album name) → Song title (Date/Clock) → Playing time (Date/Clock) → (back to the beginning)
PANDORA	Station name (Date/Clock) → Shared/Radio (Date/Clock) → Song title (Artist) → Song title (Album name) → Song title (Date/Clock) → Playing time (Date/Clock) → (back to the beginning)
SIRIUS XM	Channel number (Status) → Channel name (Status) → Artist (Status) → Song title (Status) → Content information (Status) → Category name (Status) → Date (Status) → (back to the beginning)
AUX	AUX (Date/Clock)

REFERENCES

Source name	Display information (for KD-R492/KD-R490)
FM or AM	Frequency → Clock → (back to the beginning) (For FM Radio Broadcast Data System stations/FM Radio Data signal only) Station name (PS)/Program type (PTY) → Radio text → Radio text+ → Radio text+ title/Radio text+ artist → Frequency → Clock → (back to the beginning)
CD or USB	(For CD-DA) Disc title/Artist → Track title/Artist → Playing time → Clock → (back to the beginning) (For MP3/WMA/WAV/FLAC files) Song title/Artist → Album name/Artist → Folder name → File name → Playing time → Clock → (back to the beginning)
ANDROID	When [AUTO MODE] is selected (→ 9): Song title/Artist → Album name/Artist → Playing time → Clock → (back to the beginning)
AUX	AUX → Clock → (back to the beginning)

TROUBLESHOOTING

	Symptom	Remedy
General	Sound cannot be heard.	<ul style="list-style-type: none"> Adjust the volume to the optimum level. Check the cords and connections.
	"MISWIRING CHECK WIRING THEN PWR ON" appears.	Turn the power off, then check to be sure the terminals of the speaker wires are insulated properly. Turn the power on again.
	"PROTECTING SEND SERVICE" appears.	Send the unit to the nearest service center.
Radio	Source cannot be selected.	Check the [SOURCE SELECT] setting. (→ 4)
	<ul style="list-style-type: none"> Radio reception is poor. Static noise while listening to the radio. 	Connect the antenna firmly.
CD/USB/iPod	Disc cannot be ejected.	Press and hold ▲ to forcibly eject the disc. Be careful not to drop the disc when it is ejected.
	"IN DISC" appears.	Make sure nothing is blocking the loading slot when you eject the disc.
	"PLEASE EJECT" appears.	Press ▲, then insert the disc correctly.
	Playback order is not as intended.	The playback order is determined by the file name (USB) or the order in which files were recorded (disc).
	Elapsed playing time is not correct.	This depends on the recording process earlier.
	"NOT SUPPORT" appears and track skips.	Check whether the track is a playable format. (→ 18)
	"READING" keeps flashing.	<ul style="list-style-type: none"> Do not use too many hierarchical levels and folders. Reload the disc or reattach the USB device.
"CANNOT PLAY" flashes and/or connected device cannot be detected.	<ul style="list-style-type: none"> Check whether the connected device is compatible with this unit and ensure the files are in supported formats. (→ 18) Reattach the device. 	

TROUBLESHOOTING

Symptom	Remedy	
CD/USB/iPod	The iPod/iPhone does not turn on or does not work.	<ul style="list-style-type: none"> Check the connection between this unit and iPod/iPhone. Disconnect and reset the iPod/iPhone using hard reset.
	Correct characters are not displayed.	<ul style="list-style-type: none"> This unit can only display uppercase letters, numbers, and a limited number of symbols. Depending on the display language you have selected (➔ 5), some characters may not be displayed correctly.
ANDROID	<ul style="list-style-type: none"> Sound cannot be heard during playback. Sound output only from the Android device. 	<ul style="list-style-type: none"> Reconnect the Android device. If in [AUDIO MODE], launch any media player application on the Android device and start playback. If in [AUDIO MODE], relaunch the current media player application or use another media player application. Restart the Android device. If this does not solve the problem, the connected Android device is unable to route the audio signal to unit. (➔ 19)
	Cannot playback at [AUTO MODE].	<ul style="list-style-type: none"> Make sure JVC MUSIC PLAY APP is installed on the Android device. (➔ 8) Reconnect the Android device and select the appropriate control mode. (➔ 9) If this does not solve the problem, the connected Android device does not support [AUTO MODE]. (➔ 19)
	"NO DEVICE" or "READING" keeps flashing.	<ul style="list-style-type: none"> Switch off the developer options on the Android device. Reconnect the Android device. If this does not solve the problem, the connected Android device does not support [AUTO MODE]. (➔ 19)

Symptom	Remedy	
ANDROID	Playback is intermittent or sound skips.	Turn off the power saving mode on the Android device.
	"CANNOT PLAY"	<ul style="list-style-type: none"> Make sure Android device contains playable audio files. Reconnect the Android device. Restart the Android device.
Pandora	"ADD ERROR"	New station creation is unsuccessful.
	"CHK DEVICE"	Check the Pandora application on your device.
	"NO SKIPS"	The skip limit has been reached.
	"NO STATIONS"	No stations are found.
	"STATION LMT"	The number of registered stations has reached its limit. Retry after deleting unnecessary stations from your device.
	"UPGRADE APP"	Make sure you have installed the latest version of the Pandora application on your device.
	"CONNECT ERR"	Communication is unstable.
	"RATING ERR"	Registration of thumbs up/thumbs down has failed due to insufficient network connectivity.
SiriusXM® Radio	"THUMBS N/A"	Registration of thumbs up/thumbs down is not allowed.
	"LICENSE ERR"	You try to access from a country which Pandora is not deliverable.
	"CH LOCKED LOCK CODE?"	The selected channel is locked. Enter the correct pass code to unlock. (➔ 13)
	"CHAN UNSUB"	The selected channel is unsubscribed. Call 1-866-635-2349 in U.S.A. or 1-877-438-9677 in Canada to subscribe.

TROUBLESHOOTING

Symptom	Remedy
"CH UNAVAIL"	The selected channel is unavailable. For more information about the SiriusXM channel lineup, visit <www.siriusxm.com>.
"CHECK ANTENNA"	Check the antenna and its connection are in good condition.
"CHECK TUNER"	Make sure the SiriusXM Vehicle Tuner is connected to the unit.
"NO SIGNAL"	Make sure the antenna is mounted outside the vehicle.
"SUBSCRIPTION UPDATED – PRESS ENTER TO CONTINUE."	Your subscription is updated. Press the volume knob to continue.
"CODE ERROR"	Make sure you have entered the correct pass code. (➔ 13)
"NO CONTENT"	There is insufficient content to start TuneScan.
"SCAN CANCEL"	TuneScan has been aborted.

If you have any troubles, try the following:

- 1 Check TROUBLESHOOTING
- 2 Reset the unit (➔ 3)
- 3 Contact (USA only)
Call: 1-800-252-5722 (or) visit: <http://www.jvc.com>

INSTALLATION/CONNECTION

⚠ Warning

- The unit can only be used with a 12 V DC power supply, negative ground.
- Disconnect the battery's negative terminal before wiring and mounting.
- Do not connect Battery wire (yellow) and Ignition wire (red) to the car chassis or Ground wire (black) to prevent a short circuit.
- To prevent short circuit:
 - Insulate unconnected wires with vinyl tape.
 - Be sure to ground this unit to the car's chassis again after installation.
 - Secure the wires with cable clamps and wrap vinyl tape around the wires that comes into contact with metal parts to protect the wires.

⚠ Caution

- For safety's sake, leave wiring and mounting to professionals. Consult the car audio dealer.
- Install this unit in the console of your vehicle. Do not touch the metal parts of this unit during and shortly after use of the unit. Metal parts such as the heat sink and enclosure become hot.
- Do not connect the ⊖ wires of speakers to the car chassis or Ground wire (black), or connect them in parallel.
- Connect speakers with a maximum power of more than 50 W. If the maximum power of the speakers is lower than 50 W, change the [AMP GAIN] setting to avoid damaging the speakers. (➔ 16)
- Mount the unit at an angle of less than 30°.
- If your vehicle wiring harness does not have the ignition terminal, connect Ignition wire (red) to the terminal on the vehicle's fuse box which provides 12 V DC power supply and is turned on and off by the ignition key.
- Keep all cables away from heat dissipate metal parts.
- After the unit is installed, check whether the brake lamps, blinkers, wipers, etc. on the car are working properly.
- If the fuse blows, first make sure the wires are not touching car's chassis, then replace the old fuse with one that has the same rating.

INSTALLATION/CONNECTION

Part list for installation

(A) Faceplate

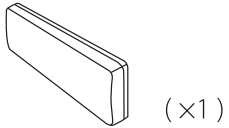

(×1)

(B) Trim plate

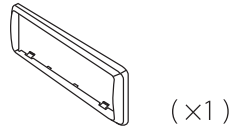

(×1)

(C) Mounting sleeve

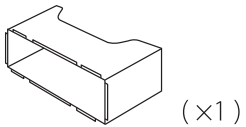

(×1)

(D) Wiring harness

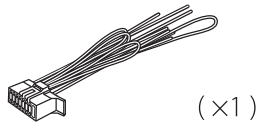

(×1)

(E) Extraction key

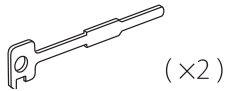

(×2)

Installing the unit (in-dash mounting)

1

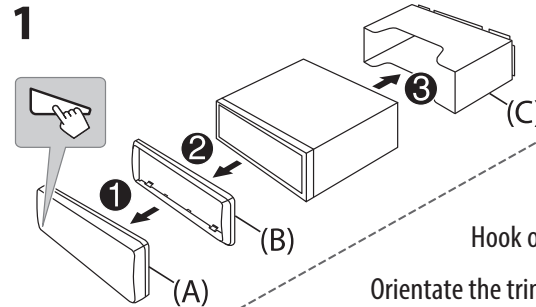

2

Hook on the top side
Orientate the trim plate as illustrated before fitting.

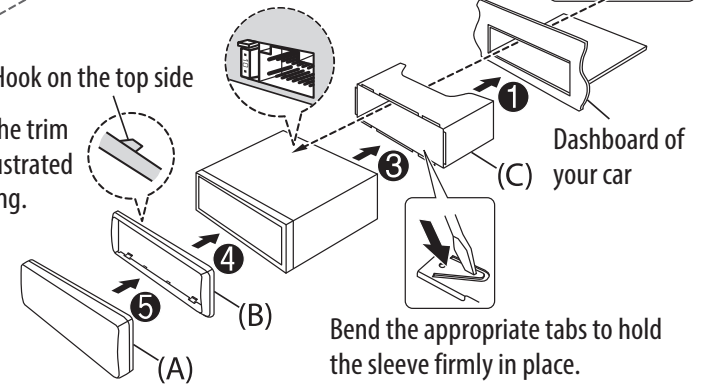

Bend the appropriate tabs to hold the sleeve firmly in place.

Basic procedure

- 1 Remove the key from the ignition switch, then disconnect the \ominus terminal of the car battery.
- 2 Connect the wires properly.
See Wiring connection. (→ 24)
- 3 Install the unit to your car.
See Installing the unit (in-dash mounting).
- 4 Connect the \ominus terminal of the car battery.
- 5 Detach the faceplate and reset the unit. (→ 3)

When installing without the mounting sleeve

- 1 Remove the mounting sleeve and trim plate from the unit.
- 2 Align the holes in the unit (on both sides) with the vehicle mounting bracket and secure the unit with screws (commercially available).

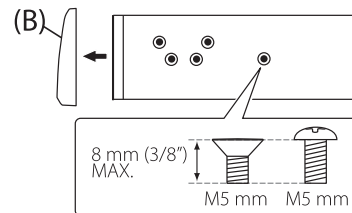

⚠ Use only the specified screws. Using wrong screws might damage the unit.

How to remove the unit

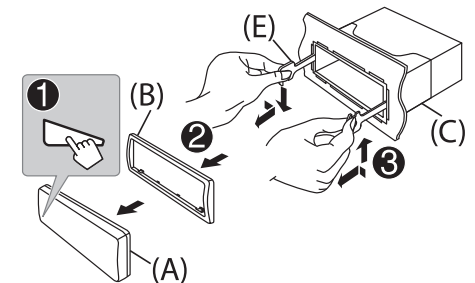

INSTALLATION/CONNECTION

Wiring connection

IMPORTANT

We recommend installing the unit with a commercially available custom wiring harness specific for your car and leave this job to professionals for your safety. Consult your car audio dealer.

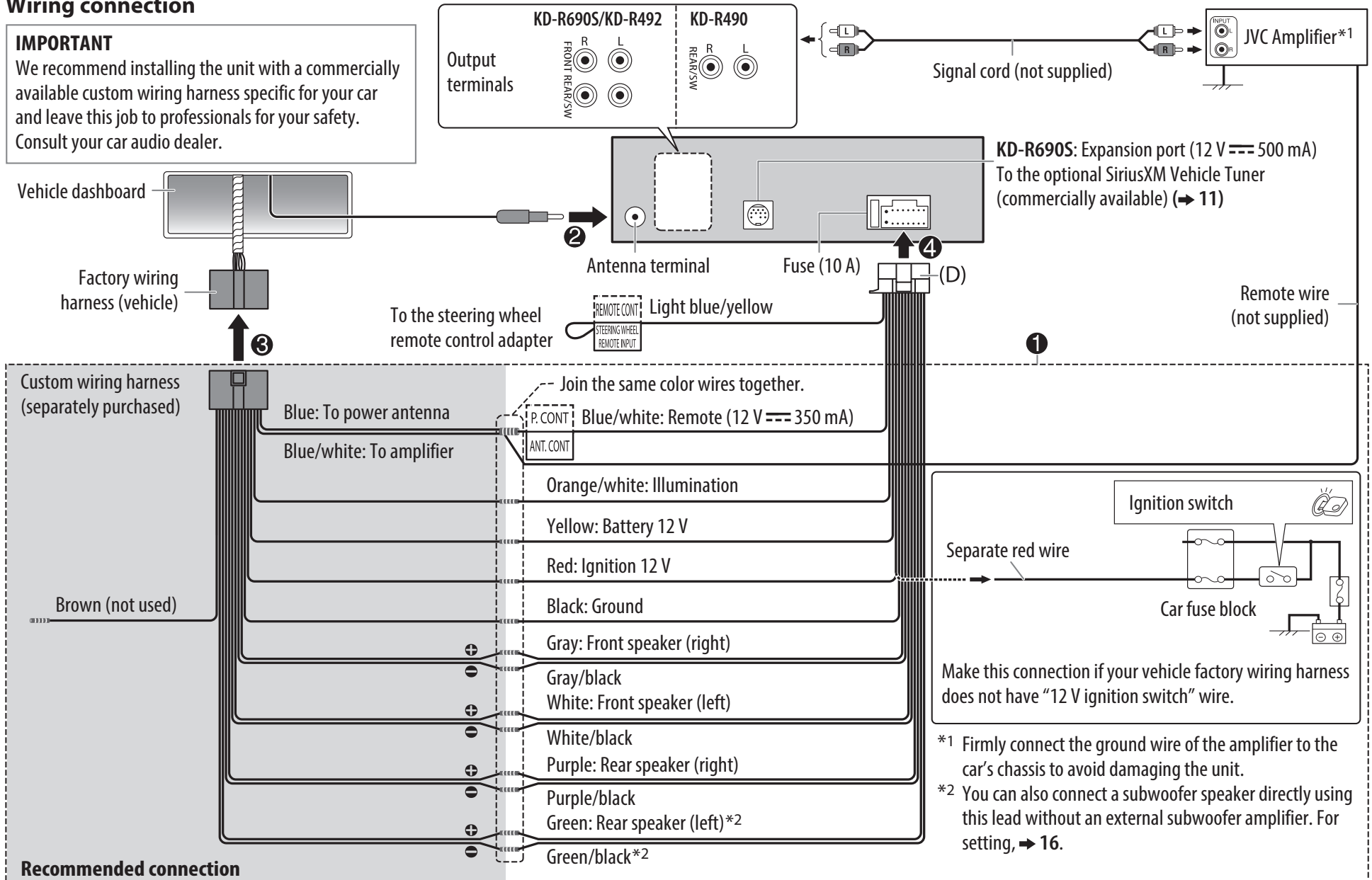

SPECIFICATIONS

Subject to change without notice.

Tuner	FM Frequency Range	87.9 MHz — 107.9 MHz (200 kHz step) 87.5 MHz — 108.0 MHz (50 kHz step)
	Usable Sensitivity (S/N = 26 dB)	8.2 dBf (0.71 μ V/75 Ω)
	Quieting Sensitivity (DIN S/N = 46 dB)	17.2 dBf (2.0 μ V/75 Ω)
	Frequency Response (\pm 3 dB)	30 Hz — 15 kHz
	Signal-to-Noise Ratio (MONO)	64 dB
	Stereo Separation (1 kHz)	40 dB
	AM Frequency Range	530 kHz — 1 700 kHz (10 kHz step) 531 kHz — 1 611 kHz (9 kHz step)
	Usable Sensitivity (S/N = 20 dB)	29 dB μ (28.2 μ V)
CD player	Laser Diode	GaAlAs
	Digital Filter (D/A)	8 times over sampling
	Spindle Speed	500 rpm — 200 rpm (CLV)
	Wow & Flutter	Below measurable limit
	Frequency Response (\pm 1 dB)	20 Hz — 20 kHz
	Total Harmonic Distortion (1 kHz)	0.01 %
	Signal-to-Noise Ratio (1 kHz)	105 dB
	Dynamic Range	90 dB
	Channel Separation	85 dB
	MP3 Decode	Compliant with MPEG-1/2 Audio Layer-3
	WMA Decode	Compliant with Windows Media Audio
USB	USB Standard	USB 1.1, USB 2.0 (Full speed)
	Compatible Devices	Mass storage class
	File System	FAT12/16/32
	Maximum Supply Current	DC 5 V \leq 1 A
	D/A Converter	24 Bit

USB	Frequency Response (\pm 1 dB)	20 Hz — 20 kHz
	Signal-to-Noise Ratio (1 kHz)	105 dB
	Dynamic Range	90 dB
	Channel Separation	85 dB
	MP3 Decode	Compliant with MPEG-1/2 Audio Layer-3
	WMA Decode	Compliant with Windows Media Audio
	WAV Decode	Linear-PCM
	FLAC Decode	FLAC files
Auxiliary	Frequency Response (\pm 3 dB)	20 Hz — 20 kHz
	Input Maximum Voltage	1 000 mV
	Input Impedance	30 k Ω
Audio	Maximum Output Power	50 W \times 4 or 50 W \times 2 + 50 W \times 1 (Subwoofer = 4 Ω)
	Full Bandwidth Power (at less than 1 % THD)	22 W \times 4
	Speaker Impedance	4 Ω — 8 Ω
	Preout Level/Load (CD/USB)	2 500 mV/10 k Ω load
	Preout Impedance	\leq 600 Ω
General	Operating Voltage (10.5 V — 16 V allowable)	14.4 V
	Maximum Current Consumption	10 A
	Operating Temperature Range	-10°C — +60°C
	Installation Size (W \times H \times D)	182 mm \times 53 mm \times 158 mm (7-3/16" \times 2-1/8" \times 6-1/4")
	Net Weight (includes Trimplate, Mounting Sleeve)	1.2 kg (2.7 lbs)

CAUTION

Use of controls or adjustments or performance of procedures other than those specified herein may result in hazardous radiation exposure.

In compliance with Federal Regulations, following are reproductions of labels on, or inside the product relating to laser product safety.

JVC KENWOOD Corporation
2967-3, ISHIKAWA-MACHI,
HACHIOJI-SHI, TOKYO, JAPAN

THIS PRODUCT COMPLIES WITH DHHS RULES 21CFR
SUBCHAPTER J IN EFFECT AT DATE OF MANUFACTURE.

Location : Top Plate

FCC WARNING

This equipment may generate or use radio frequency energy. Changes or modifications to this equipment may cause harmful interference unless the modifications are expressly approved in the instruction manual. The user could lose the authority to operate this equipment if an unauthorized change or modification is made.

FCC NOTE

This equipment has been tested and found to comply with the limits for a Class B digital device, pursuant to Part 15 of the FCC Rules. These limits are designed to provide reasonable protection against harmful interference in a residential installation. This equipment may cause harmful interference to radio communications, if it is not installed and used in accordance with the instructions. However, there is no guarantee that interference will not occur in a particular installation. If this equipment does cause harmful interference to radio or television reception, which can be determined by turning the equipment off and on, the user is encouraged to try to correct the interference by one or more of the following measures:

- Reorient or relocate the receiving antenna.
- Increase the separation between the equipment and receiver.
- Connect the equipment into an outlet on a circuit different from that to which the receiver is connected.
- Consult the dealer or an experienced radio/TV technician for help.

Información acerca de la eliminación de equipos eléctricos y electrónicos al final de la vida útil (aplicable a los países que hayan adoptado sistemas independientes de recogida de residuos)



Los productos con el símbolo de un contenedor con ruedas tachado no podrán ser desechados como residuos domésticos. Los equipos eléctricos y electrónicos al final de la vida útil, deberán ser reciclados en instalaciones que puedan dar el tratamiento adecuado a estos productos y a sus subproductos residuales correspondientes. Póngase en contacto con su administración local para obtener información sobre el punto de recogida más cercano. Un tratamiento correcto del reciclaje y la eliminación de residuos ayuda a conservar los recursos y evita al mismo tiempo efectos perjudiciales en la salud y el medio ambiente.

- Microsoft and Windows Media are either registered trademarks or trademarks of Microsoft Corporation in the United States and/or other countries.
- “Made for iPod,” and “Made for iPhone” mean that an electronic accessory has been designed to connect specifically to iPod, or iPhone, respectively, and has been certified by the developer to meet Apple performance standards. Apple is not responsible for the operation of this device or its compliance with safety and regulatory standards. Please note that the use of this accessory with iPod or iPhone may affect wireless performance.
- iPhone, iPod, iPod classic, iPod nano, and iPod touch are trademarks of Apple Inc., registered in the U.S. and other countries.
- Lightning is a trademark of Apple Inc.
- Pandora, the Pandora logo, and the Pandora trade dress are trademarks or registered trademarks of Pandora Media, Inc., used with permission.
- Sirius, XM and all related marks and logos are trademarks of Sirius XM Radio Inc. All rights reserved.
- Android is trademark of Google Inc.

libFLAC

Copyright (C) 2000-2009 Josh Coalson

Copyright (C) 2011-2013 Xiph.Org Foundation

Redistribution and use in source and binary forms, with or without modification, are permitted provided that the following conditions are met:

- Redistributions of source code must retain the above copyright notice, this list of conditions and the following disclaimer.
- Redistributions in binary form must reproduce the above copyright notice, this list of conditions and the following disclaimer in the documentation and/or other materials provided with the distribution.
- Neither the name of the Xiph.org Foundation nor the names of its contributors may be used to endorse or promote products derived from this software without specific prior written permission.

THIS SOFTWARE IS PROVIDED BY THE COPYRIGHT HOLDERS AND CONTRIBUTORS “AS IS” AND ANY EXPRESS OR IMPLIED WARRANTIES, INCLUDING, BUT NOT LIMITED TO, THE IMPLIED WARRANTIES OF MERCHANTABILITY AND FITNESS FOR A PARTICULAR PURPOSE ARE DISCLAIMED. IN NO EVENT SHALL THE FOUNDATION OR CONTRIBUTORS BE LIABLE FOR ANY DIRECT, INDIRECT, INCIDENTAL, SPECIAL, EXEMPLARY, OR CONSEQUENTIAL DAMAGES (INCLUDING, BUT NOT LIMITED TO, PROCUREMENT OF SUBSTITUTE GOODS OR SERVICES; LOSS OF USE, DATA, OR PROFITS; OR BUSINESS INTERRUPTION) HOWEVER CAUSED AND ON ANY THEORY OF LIABILITY, WHETHER IN CONTRACT, STRICT LIABILITY, OR TORT (INCLUDING NEGLIGENCE OR OTHERWISE) ARISING IN ANY WAY OUT OF THE USE OF THIS SOFTWARE, EVEN IF ADVISED OF THE POSSIBILITY OF SUCH DAMAGE.

Informação sobre a eliminação de pilhas

Este produto não deve ser eliminado como lixo doméstico geral. Devolva a pilha usada ao revendedor ou entidade autorizada para que a mesma seja devolvida ao fabricante ou importador. A reciclagem e a eliminação de lixo de maneira apropriada ajudarão a conservar os recursos naturais ao mesmo tempo que prevenirão os efeitos prejudiciais à nossa saúde e ao meio ambiente.

CALIFORNIA, USA ONLY

This product contains a CR Coin Cell Lithium Battery which contains Perchlorate Material—special handling may apply.

See www.dtsc.ca.gov/hazardouswaste/perchlorate

WHEN IT IS NOT REQUIRED
TO DETACH THE FRONT CONTROL
PANEL FROM THE MAIN UNIT,
USE THE PROVIDED SCREW TO
ATTACH THE CONTROL PANEL TO
THE MAIN UNIT.

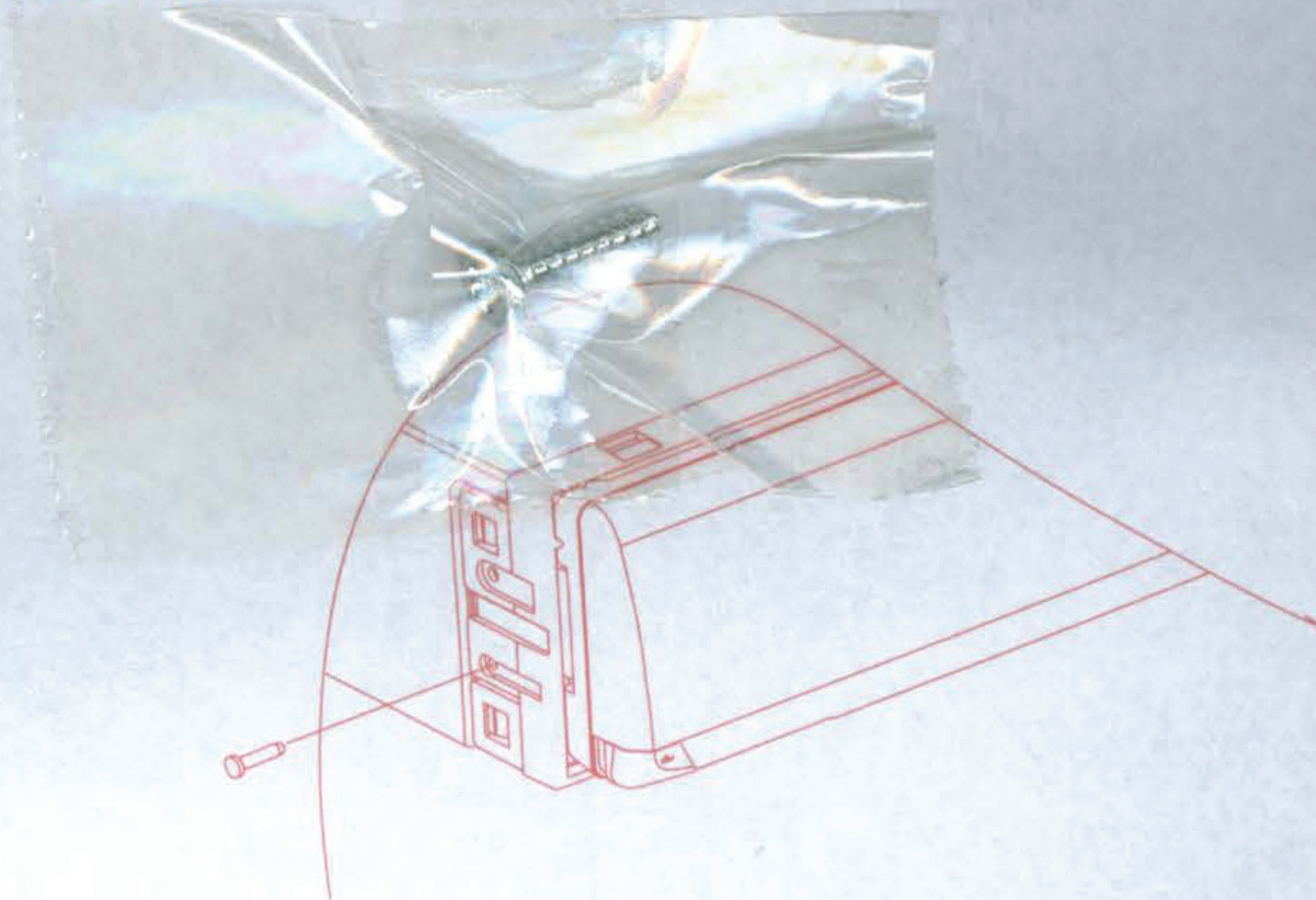

GE40401-001A

REMOVE THIS LABEL FROM CABLE BEFORE USE.
RETIRE LA ETIQUETA DEL CABLE ELÉCTRICO ANTES DE USAR.
RETIREZ CETTE ÉTIQUETTE DU CÂBLE AVANT UTILISATION.



CAUTION

CONNECT BLACK WIRE (① GND) TO GROUND FIRST. OTHERWISE, DAMAGE TO YOUR UNIT MAY OCCUR.

INCORRECT CONNECTION CAUSES SERIOUS DAMAGE TO THIS UNIT
PLEASE READ INSTALLATION/CONNECTION MANUAL CAREFULLY.

①

CONNECT GROUND FIRST

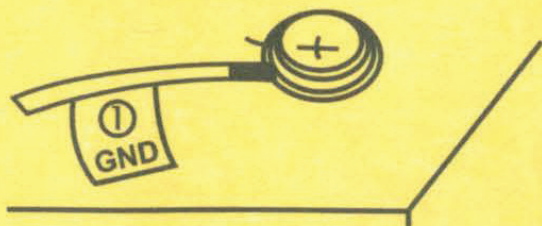

METALLIC BODY OR CHASSIS
OF THE CAR

②

CONNECT OTHER WIRES

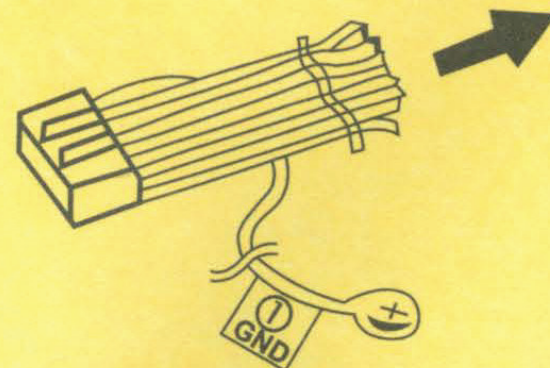

③

CONNECT ANTENNA TERMINAL

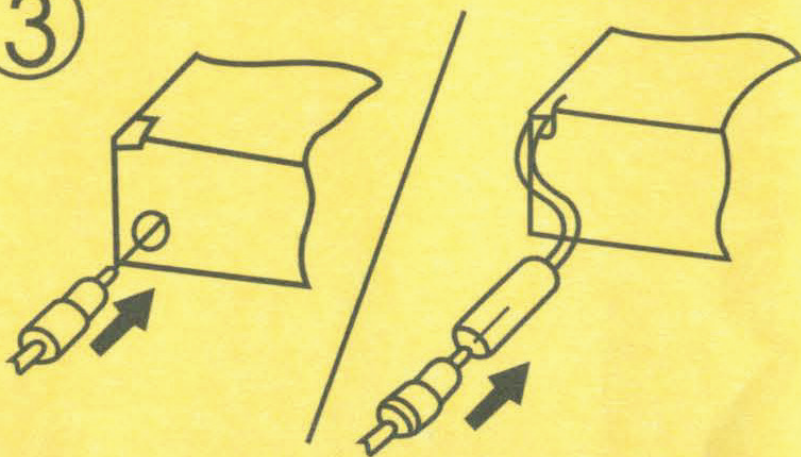

④

CONNECT POWER CORD TO
THE UNIT

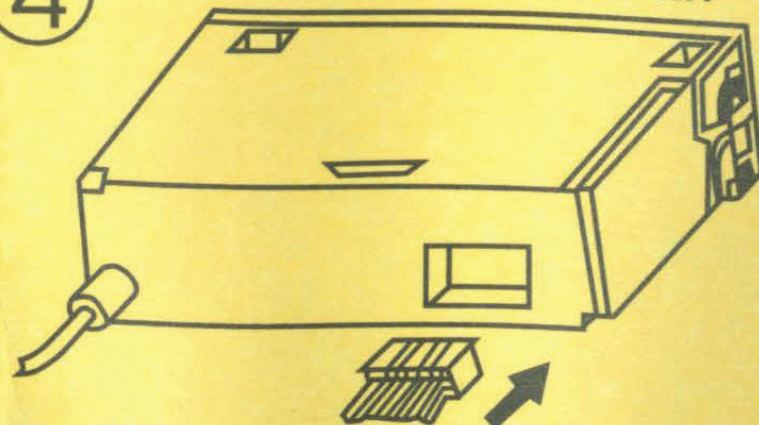

TO OUR VALUED CUSTOMER

THANK YOU FOR PURCHASING THIS JVC PRODUCT.
WE WANT TO HELP YOU ACHIEVE A PERFECT EXPERIENCE.

**NEED HELP ON HOW TO HOOK UP?
NEED ASSISTANCE ON HOW TO OPERATE?
NEED TO LOCATE A JVC SERVICE CENTER?
LIKE TO PURCHASE ACCESSORIES?**

JVC IS HERE TO HELP!
TOLL FREE: 1 (800)252-5722
<http://www.us.jvckenwood.com>

Remember to retain your Bill of Sale for Warranty Service.
Do not attempt to service the product yourself

Caution

To prevent electrical shock, do not open the cabinet.
There are no user serviceable parts inside.
Please refer to qualified service personnel for repairs.

PRODUCT REGISTRATION

We suggest that you register your product since it will enable us to contact you directly if it is ever necessary to correct a safety related condition in your product. You can register at <http://www.us.jvckenwood.com>
Please note that failure to register does not diminish any of your rights during the warranty period.

JVC

LIMITED WARRANTY

ONLY FOR PRODUCT PURCHASED IN U.S.A.

JVCKENWOOD USA Corporation warrants this product and all parts thereof, except as set forth below ONLY TO THE ORIGINAL RETAIL PURCHASER to be FREE FROM DEFECTIVE MATERIALS AND WORKMANSHIP from the date of original purchase for the period shown below. ("The Warranty Period")

PARTS 2 YRS / LABOR 2 YRS : Car audio ARSENAL series

PARTS 1 YR / LABOR 1 YR : All other car audio products

THIS LIMITED WARRANTY IS VALID ONLY IN THE FIFTY (50) UNITED STATES, THE DISTRICT OF COLUMBIA AND IN THE COMMONWEALTH OF PUERTO RICO.

WHAT WE WILL DO:

If this product is found to be defective within the warranty period, JVC will repair or replace defective parts with new or rebuilt equivalents at no charge to the original owner. Such repair and replacement services shall be rendered by JVC during normal business hours at JVC authorized service centers. Parts used for replacement are warranted only for the remainder of the Warranty Period. All products may be brought to a JVC authorized service center on a carry-in basis.

WHAT YOU MUST DO FOR WARRANTY SERVICE:

Please do not return your product to the retailer. Instead, return your product to the JVC authorized service center nearest you. If shipping the product to the service center, please be sure to package it carefully, preferably in the original packaging, and include a brief description of the problem(s) and a copy of the proof of purchase to verify purchase date. Please call 1-800-252-5722 to locate the nearest JVC authorized service center. Service locations can also be obtained from our website <http://www.us.jvckenwood.com>.

If you have any questions concerning your JVC Product, please contact our Customer Care Center at 800-252-5722

WHAT IS NOT COVERED:

This limited warranty provided by JVC does not cover:

1. Products which have been subject to abuse, accident, alteration, modification, tampering, negligence, misuse, faulty installation, lack of reasonable care, or if repaired or serviced by anyone other than a service facility authorized by JVC to render such service, or if affixed to any attachment not provided with the products, or if the model or serial number has been altered, tampered with, defaced or removed;
2. Initial installation, installation and removal from cabinets or mounting systems.
3. Operational adjustments covered in the Owner's Manual, normal maintenance, video and audio head cleaning;
4. Damage that occurs in shipment, due to act of God, and cosmetic damage;
5. Signal reception problems and failures due to line power surge;
6. User Removal Memory Devices/Video Pick-up Tubes/CCD Image Sensors are covered for 90 days from the date of purchase;
7. Accessories;
8. Batteries (except that Rechargeable Batteries are covered for 90 days from the date of purchase);
9. Products used for commercial purposes, including, but not limited to rental.
10. Loss of data resultant from malfunction of hard drive or other data storage device;

There are no express warranties except as listed above.

THE DURATION OF ANY IMPLIED WARRANTIES, INCLUDING THE IMPLIED WARRANTY OF MERCHANTABILITY, IS LIMITED TO THE DURATION OF THE EXPRESS WARRANTY HEREIN. JVC SHALL NOT BE LIABLE FOR ANY LOSS OF USE OF THE PRODUCT, INCONVENIENCE, OR ANY OTHER DAMAGES, WHETHER DIRECT, INCIDENTAL OR CONSEQUENTIAL (INCLUDING, WITHOUT LIMITATION, DAMAGE TO TAPES, RECORDS OR DISCS) RESULTING FROM THE USE OF THIS PRODUCT, OR ARISING OUT OF ANY BREACH OF THIS WARRANTY. ALL EXPRESS AND IMPLIED WARRANTIES, INCLUDING THE WARRANTIES OF MERCHANTABILITY AND FITNESS FOR PARTICULAR PURPOSE, ARE LIMITED TO THE WARRANTY PERIOD SET FORTH ABOVE.

Some states do not allow the exclusion of incidental or consequential damages or limitations on how long an implied warranty lasts, so these limitations or exclusions may not apply to you. This warranty gives you specific legal rights and you may also have other rights which vary from state to state.

JVCKENWOOD USA Corporation

PO Box 22745, 2201 East Dominguez Street, Long Beach, CA90801-5745
<http://www.us.jvckenwood.com>

REFURBISHED PRODUCTS CARRY A SEPARATE WARRANTY, THIS WARRANTY DOES NOT APPLY. FOR DETAIL OF REFURBISHED PRODUCT WARRANTY, PLEASE REFER TO THE REFURBISHED PRODUCT WARRANTY INFORMATION PACKAGED WITH EACH REFURBISHED PRODUCT.

For customer use:

Enter below the Model No. and Serial No. which is located either on the rear, bottom or side of the cabinet. Retain this information for future reference.

Model No.: _____

Serial No.: _____

Purchase date: _____

Name of dealer: _____



WARRANTY

Warranty applies only to PRODUCT distributed in Canada by JVCKENWOOD CANADA INC.

JVCKENWOOD CANADA INC. (hereafter called "JVC") gives the following express warranty for each new JVC product distributed in Canada by JVC and sold by an authorized JVC dealer. JVC warrants that this JVC product is free, under normal use and maintenance, from any defects in material and workmanship subject to the following terms and conditions:

- To Obtain Warranty Service:**
 - JVC product requiring service must be presented together with proof of purchase.
 - The JVC product must be brought in for service to an authorized JVC Service Centre.
- Limitation:**
This Warranty shall not apply to:
 - Repair or replacement of any cabinets, batteries, plates, connection cords, antennas, dust covers, knobs, speaker grills, speaker cones, projection screens, projection screen savers, and all accessories.
 - Any defects caused or repairs required as a result of misuse, abusive operation, negligence, improper use and/or insufficient care.
 - Any defect caused or repairs required as a result of not following the instructions in the operation manual.
 - Any JVC product tampered with, adjusted or repaired by any party other than JVC or authorized JVC Service Centre personnel.
 - Any JVC products on which the serial number has been defaced, modified or removed.
 - Maintenance, cleaning or periodic check-up
 - Conversion to foreign or domestic voltage or frequency.
 - Any JVC product without the Canadian Electrical Safety Regulations ID.
 - Any JVC products used for commercial or institutional, rental, or display purposes.
Parts 1 year (except video head - 90 days)
Labour ... 90 days
 - Any JVC product which has been resold and no longer owned by the original purchaser.
 - Product purchased from "outside Canada", "bankruptcy" or "liquidator".
 - Any defects caused by fire, flood, lightning, power surge, or other events beyond the control of JVC.
 - FOR AUTO PRODUCTS**
Warranty does not cover elimination of car static or electrical interferences, cleaning of head, adjustments, or labour cost for the removal or reinstallation of the unit for repair.

- Standards:**
If any defects should be found in a JVC product within the applicable terms, necessary repairs shall be made at no cost to the purchaser for parts or labour when JVC acknowledges that such defects are due to faulty material or workmanship.
- Exclusion of All Other Express Warranties:**
This warranty constitutes the entire express warranty given by JVC for JVC products and no dealer or service centre personnel or his, its or their agent or employee is, or are authorized to extend or enlarge this warranty on behalf of JVC.
- Disclaimer of Consequential Damage:**
To the extent the law permits JVC disclaims any responsibility for loss of time or use of its product, transportation costs, or any other indirect, incidental or consequential damage or inconvenience.

WARRANTY TERM (VALID FROM THE DATE OF PURCHASE)

Product	Parts (Years)	Labour (Years)
Projection TV In-Home Service Colour TV In-Home (25" and above) D-ILA Rear Projection In-Home Service LCD TV In-Home Service (25" and above)	1	1
* In-Home service to be provided where available. Where it is not available, the purchaser must assume the responsibility and expense for the proper packing, shipment and all costs associated with the delivery of the equipment to and from the closest JVC Authorized Service Centre.		
Receivers and Home Speakers purchased separately. Front Projection and Car Audio "ARSENAL" Series	2	2
AC Adapters, Remote controls, Headphones, Microphones and Projector lamps	90 days	90 days
Wood Cone Speakers	5	5
All Other Categories	1	1

JVCKENWOOD CANADA INC.

6070 Kestrel Road, Mississauga, Ontario, L5T 1S8 Canada
 TEL: (905) 670-3381 FAX: (905)670-7244 Service toll free #: 1-800-964-2650
<http://www.jvc.ca> E-mail: service@jvc.ca

Product Registration

We suggest that you register your product since it will enable us to contact you directly if it is ever necessary to correct a safety related condition in your product. You can register at <http://www.jvc.ca/www/Support/Warranty.aspx>

For customer use:

Enter below the Model No. and Serial No. which is located either on the rear, bottom or side of the cabinet. Retain this information for future reference.

Model No.: _____ Serial No.: _____
 Purchase date: _____ Name of dealer: _____

GARANTIE

La garantie s'applique seulement aux PRODUITS distribués au Canada par JVCKENWOOD CANADA INC.

JVCKENWOOD CANADA INC. (ci-après appelé "JVC") énonce la garantie expresse suivante pour tout nouveau produit JVC distribué au Canada par JVC et vendu par un détaillant JVC autorisé. JVC vous garantit que ce produit est dégage, sous utilisation et entretien normal, de tout défaut matériel et de fabrication sous réserve des modalités et conditions suivantes:

- Pour obtenir un service de garantie:**
 - Les produits JVC nécessitant un service doit être présentée avec la preuve d'achat.
 - Le produit JVC doit être apporté pour service chez un centre de service JVC autorisé.
- Restrictions:**
Cette garantie ne s'applique pas aux:
 - Réparation ou remplacement de tout cabinet, batteries, panneau avant, cordons de raccord, antennes, housses de protection, boutons, couvercs de hautparleur, cônes de hautparleur, écrans de projection, protecteurs d'écran de projection et tous les accessoires.
 - Tous défauts occasionnés ou réparations requises suite à une utilisation abusive, mauvaise, négligente et/ou une utilisation incorrecte.
 - Tous défauts occasionnés ou réparations requises suite à l'omission de suivre les recommandations du manuel d'instruction.
 - Tout produit JVC altéré, ajusté ou réparé par tout autre entreprise que JVC ou un centre de service d'entretien ou de service autorisé JVC.
 - Tout produit JVC dont le numéro de série a été altéré, modifié ou enlevé.
 - L'entretien, les vérifications périodiques et nettoyage.
 - La conversion à une fréquence ou une tension étrangère ou domestique.
 - Tout produit JVC n'ayant pas le signe d'identification qui conforme aux normes électriques Canadiennes (CSA).
 - Pour tout produit utilisé à des fins commerciales, institutionnelles, de location ou utilisé à des fins d'étalage.
Pièces 1 An (Excepté les têtes vidéo - 90 jours)
Main d'oeuvre ... 90 Jours
 - Tout produit JVC ayant été revendu et qui n'est plus la propriété de l'acheteur original.
 - Produit acheté à "l'extérieur du Canada", provenant d'une "faillite" ou d'un "liquidateur".
 - Tout dommage causé par le feu, une inondation, un éclair, une surtension ou tout autre évènement hors du contrôle de JVC.

- Pour LES PRODUITS D'AUTOMOBILE**
La garantie ne couvre pas l'élimination d'interférences statiques ou électriques de la voiture, le nettoyage de tête, les ajustements et les coûts de main d'œuvre associés à l'enlèvement ou à la réinstallation de l'unité pour réparation.
- Crîtères:**
Si un produit JVC s'avérait défectueux, selon les conditions applicables, les réparations nécessaires seront effectués sans coûts additionnels à l'acheteur pour les pièces et la main d'œuvre lorsque JVC reconnaît que de tels défauts sont causés par une défectuosité de matériel ou de fabrication.
- Exclusion de toutes autres garanties expresses :**
Cette garantie constitue l'entière garantie expresse donnée par JVC pour les produits JVC. Nul représentant ou employé d'un détaillant ou d'un service d'entretien n'est autorisé à prolonger cette garantie au nom de JVC.
- Dénégation des dommages indirects:**
Dans la mesure permise par la loi, JVC nie toute responsabilité pour perte de temps ou d'usage de ses produits, des coûts de transport ou tout autre dommage ou inconvénient indirect, accidentel et conséquent.

CONDITIONS DE GARANTIE (VALABLE À PARTIR DE LA DATE D'ACHAT)

Produit	Pieces (Années)	Main-D'oeuvre (Années)
Écrans de projection Service à Domicile Écrans de TV Couleur Service à Domicile (25" et plus) TV projection arrière D-ILA Service à Domicile Écrans de LCD Service à Domicile (25" et plus)	1	1
* Service à domicile fourni par un détaillant disponible. S'il n'y a pas de service JVC disponible à proximité, l'acheteur doit assumer la responsabilité et les coûts pour un emballage adéquat, l'expédition, ainsi que tous les coûts associés à la livraison de l'équipement chez et depuis le détaillant JVC autorisé le plus près pour un service d'entretien.		
Récepteurs et Hauts-Parleurs achetés séparément, Projecteur Avant et Audio d'Auto de Série "ARSENAL"	2	2
Adaptateurs AC, Télécommande, Casque D'écoute, Microphones et Lampe de Projecteur	90 Jours	90 Jours
Enceinte à Cône en Bois	5	5
Toutes les autres catégories	1	1

JVCKENWOOD CANADA INC.

6070 Kestrel Road, Mississauga, Ontario, L5T 1S8 Canada
 TEL: (905) 670-3381 FAX: (905)670-7244 Service toll free #: 1-800-964-2650
<http://www.jvc.ca> E-mail: service@jvc.ca

Enregistrement du produit

Nous vous conseillons d'enregistrer votre produit, car il nous permettra de vous contacter directement si jamais elle est nécessaire pour corriger un problème lié à la sécurité de votre produit. Vous pouvez vous inscrire à <http://www.jvc.ca/www/Support/Warranty.aspx>

Pour l'utilisation des clients:

Entrez ci-dessous le numéro de modèle et le numéro de série qui se trouve soit à l'arrière, en bas ou sur le côté de l'armoire. Conservez ces informations pour référence future.

No. de modèle: _____ No. de série: _____
 Date d'achat: _____ Nom du revendeur: _____